



Microplate Washer



NB-12-0034

Microplate Washer

#Cat: NB-12-0034	Size: 1pcs
#Cat: NB-12-0034-01	Size: 1pcs
#Cat: NB-12-0034-02	Size: 1pcs
#Cat: NB-12-0034-03	Size: 1pcs
#Cat: NB-12-0034-04	Size: 1pcs

Foreword

Thank you for purchasing our Microplate Washer. This user manual describes how the instrument works, and also includes operation guide, please read carefully before operating and keep for future reference.

Opening check

Please check the package according to packing list when you first open it. If anything wrong or missing, please contact distributor or manufacturer.

Safety warning and guidelines

1 Important guidelines

Please read this user manual carefully before using.



Injury may happen if not following this instruction to operate the device. In order to avoid this, please read the safety tips and follow the instruction.



This instrument intended to use in Scientific Research only!

2 Safety



Indoor use only.

Warning: Biological contamination!! All samples for test, quality control or calibration are regarded as infectious, and any part contact with samples will also need to be treated as infectious. Please wear gloves before operating this device.



Only users with experience can use this instrument.

Do not put hand on the moving part when running.



Do not try to repair it without permission. Please contact distributor for repair.



Make sure using the right voltage. If the power cable is broken, replace it with same type. Unplug it carefully when finish using.



It should be in low humidity, low dust place, far away from sunshine, gas heat and magnet.



Turn off the power if does not use it for a long time, keep it away from dust.



Please shut off the power supply quickly if any of the following situation happens, then contact the distributor for repair:

- ★ Fluid sprayed into the instrument
- ★ Exposed in rain or water
- ★ Unusual noise or smell occurs
- ★ Fell onto the ground or shell broken
- ★ Malfunction

3 Maintenance

The platform and rack should be cleaned by alcohol regularly.

CONTENTS

CHAPTER 1	INTRODUCTION	1
CHAPTER 2	FEATURES	2
CHAPTER 3	STRUCTURE	3
CHAPTER 4	INSTALLATION	5
CHAPTER 5	SOFTWARE	8
CHAPTER 6	WASH PROGRAM RUNNING	18
CHAPTER 7	CREATE WASH PROGRAM	22
CHAPTER 8	IMPORT, EXPORT AND DELETE PROGRAM	26
CHAPTER 9	POWER OFF	29
CHAPTER 10	MAINTENANCE	30
CHAPTER 11	TROUBLE SHOOTING	31
APPENDIX:	DIAGRAM	32

Chapter 1 Introduction

Neo Biotech Microplate Washer is an accessory of Microplate Reader, and it's designed for wash ELISA plates after detecting, mainly to depart the binder phase and free phase, it is reliable, easy and fit for various kinds of ELISA plates.

Features:

- 4.3 inch LCD display, easy operation.
- Reliable and high efficiency, suitable for micro plates with Flat type, U type, V type and C type bottom.
- Digital display, accuracy of the wash head parameter can reach to 0.1mm.
- Several wash programs for selection.
- Any sample volume, can wash different rows. Each row corresponds to the keyboard.
- Pause function can pause the current program.
- Wash bottles has even tick mark, easy to pour the wash fluid. There is warning when fluid is over or waste fluid is full.
- Low remain fluid, each well average $\leq 1\mu\text{L}$.
- Bevel design in the bottom of the plate platform. Spilled and leaked fluid will be extracted automatically to avoid contamination of Micro plate.

Chapter 2 Features

Working condition

Environment temperature: 4°C ~ 25°C

45°C Relative humidity: ≤70%

Power supply: AC 90-240V 50/60Hz

Parameters and features

Parameters	Model	Plate Washer
Wash head		8 needles or 12 needles
Wash method		1 point, 2 points, 3 points wash
Micro plates		96 wells
Micro plates types		Flat bottom, U bottom, V bottom, C bottom
Remain liquid		≤1uL(each well)
Liquid amount		50uL~2000uL
Liquid injection accuracy		≤2% @300uL
Liquid injection precision		CV≤1.5%
Wash times		1~99
Programs		100
Wash pipeline time		00:00~03:59 (mm: ss)
Immerse and vibration time		00:00~99:00 (mm: ss)
Wash warning		Yes
Wash liquid channel		3 channels
Waste spilling warning		Yes
Waste discharge		Yes
Dimensions (WxDXH)		345 x 460 x 200mm
Net weight		11.5kg

Chapter 3 Structure

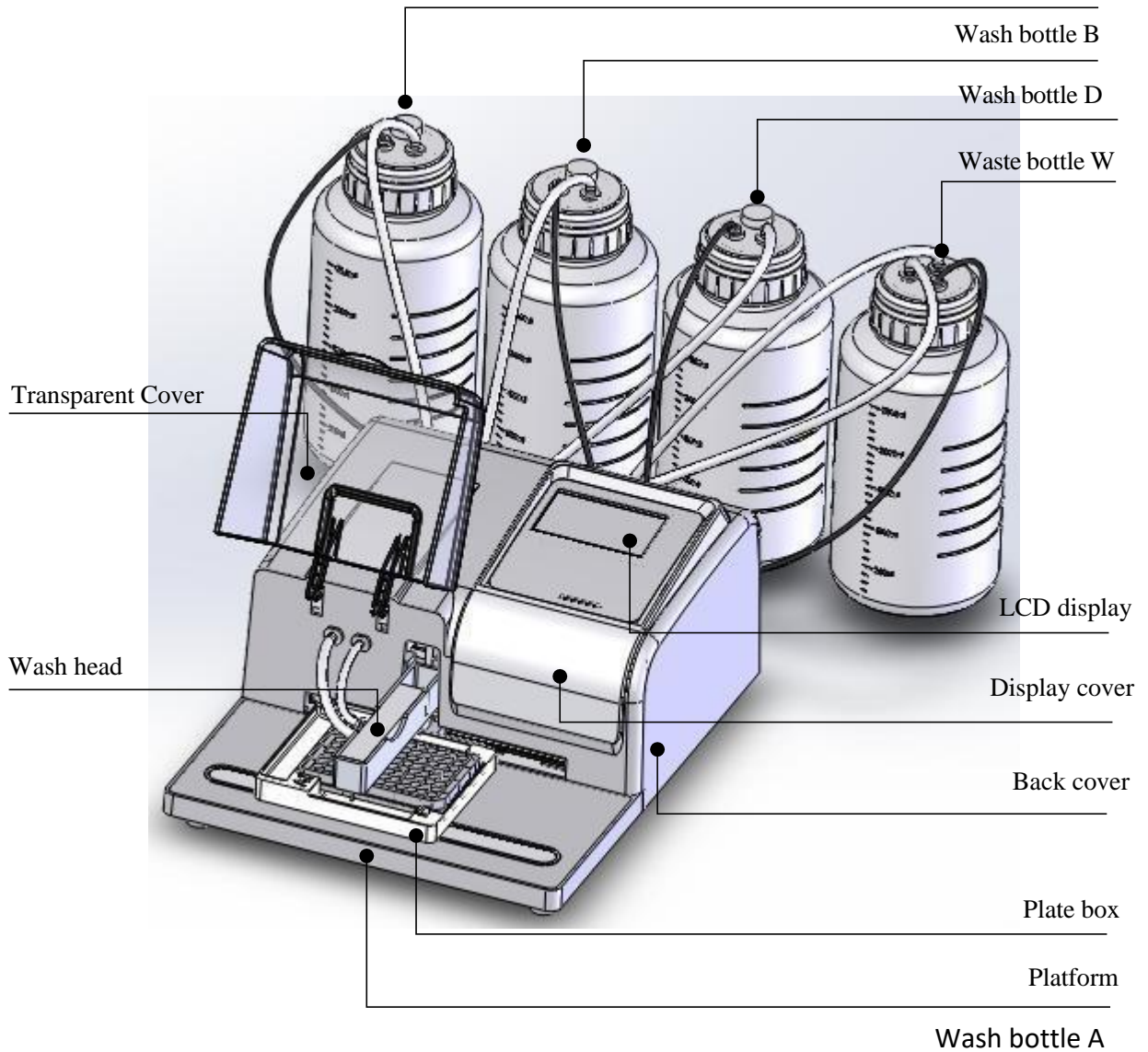

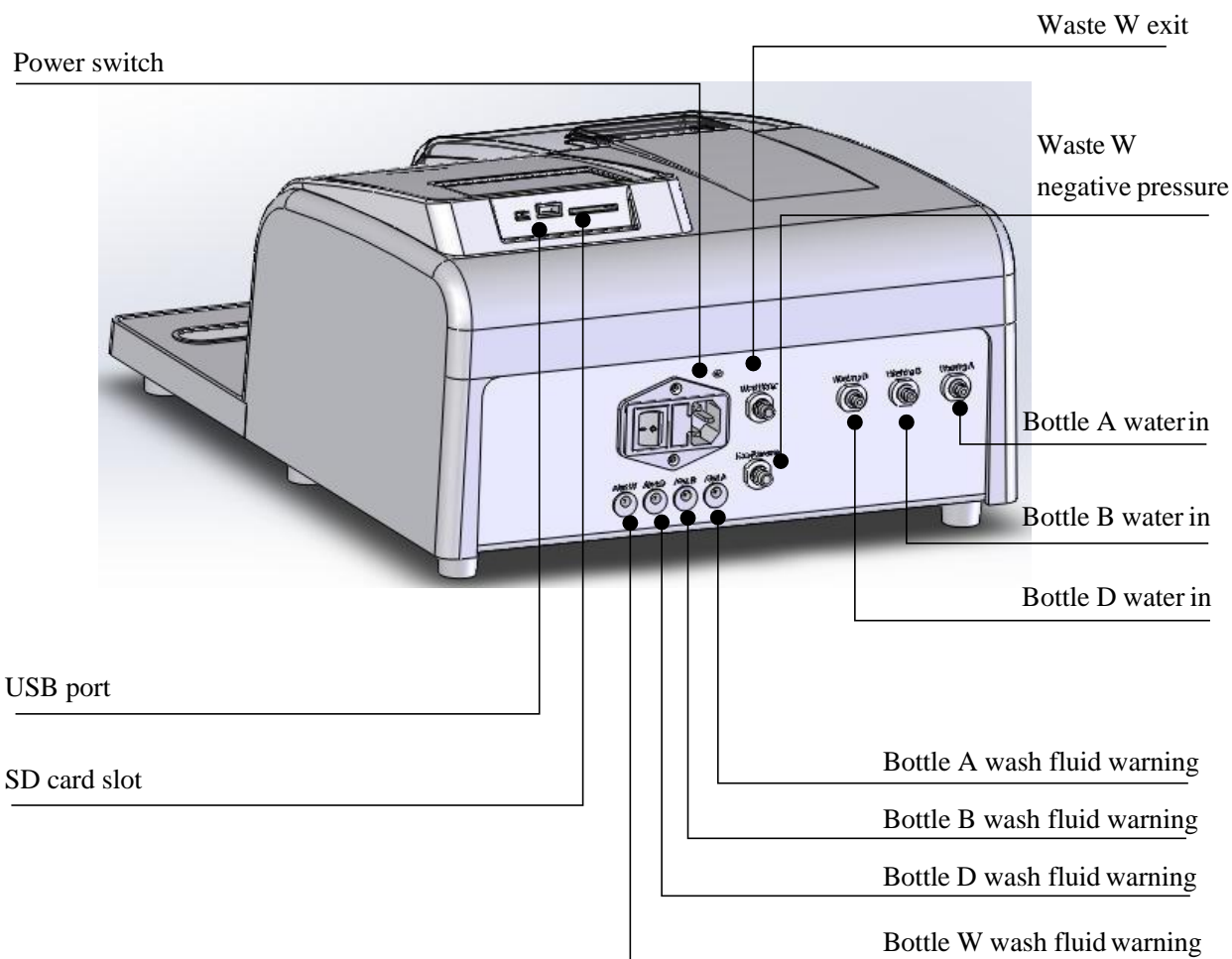

USB port

It can connect U disk via USB port, and can transfer the programs between different washers with same model via U disk.

Wash head

2 wash heads available :1X8/96 and 1X12/96 as below pictures:

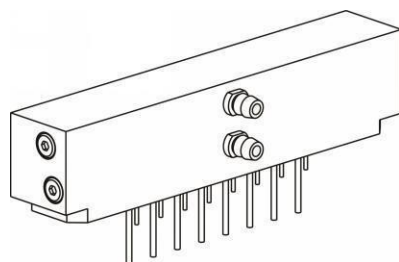

1X8/96 wash head

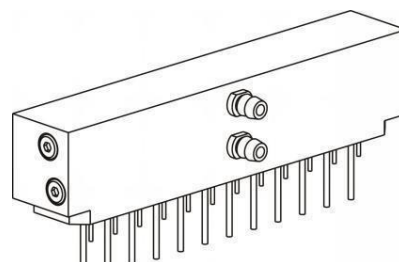

1X12/96 wash head

Chapter4 Installation

Appearance

Check the instrument when receive the package, if any below situations happen, please contact your distributor.

- Package damaged or deformed.
- Package wet.
- Package has been opened before.
- Check accessories according to packing list, make sure each item was included in.
- If there is any damage with the Microplate Washer..

Installation steps

- Open the package, take out the four bottles, wash heads, power supply and the instrument onto a flat desk.
- Check if accessories are in well condition.



Attention: Make sure the safety lock is unlocked before operating.

Way to unlock the safety lock:

Detach the screws on the wash head rack by screw driver.



Wash head installation

Connect silicone pipes as the following picture.

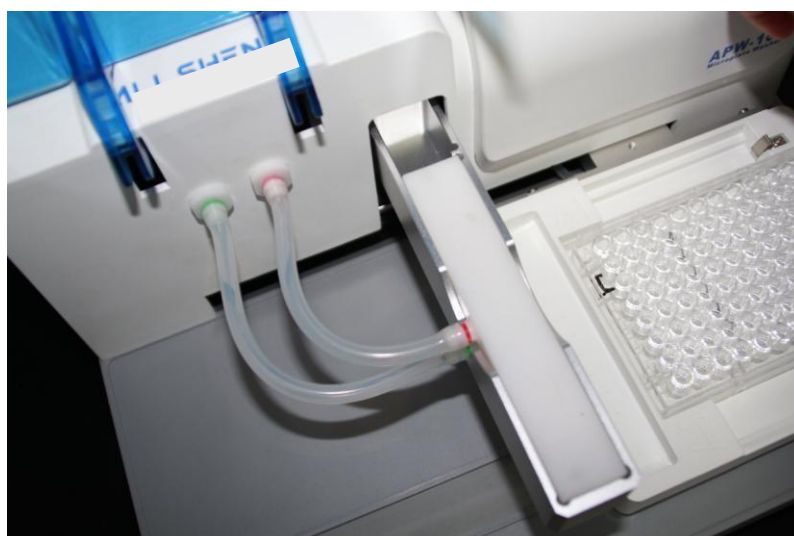
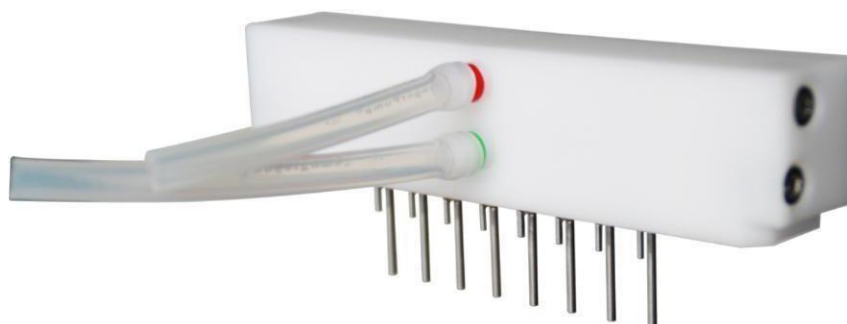

Put the wash head onto the rack and connect the silicone pipe to the machine as below picture.(1X8/96 and 1X12/96 has same installation method)

Wash bottles connection: Connect bottles according to colors as below shows:

Description		Color	Description	
Bottle W non-pressure output	Non-pressure	Yellow	Bottle A fluid level warning	Alert A
Bottle A fluid output	Washing A	Black	Bottle B fluid level warning	Alert B
Bottle B fluid output	Washing B	Blue	Bottle D fluid level warning	Alert D
Bottle D fluid Output	Washing D	Purple	Bottle W fluid level warning	Alert W
Bottle W fluid input	Waste water	Red		

The standard accessories include 3pcs wash bottles(2.5L) and 1pc waste bottle(2.5L) And pipelineA, Pipeline B, Pipeline D and Pipeline W.

The names of the wash bottles are wash solution A, wash solution B, wash D and Waste Water.

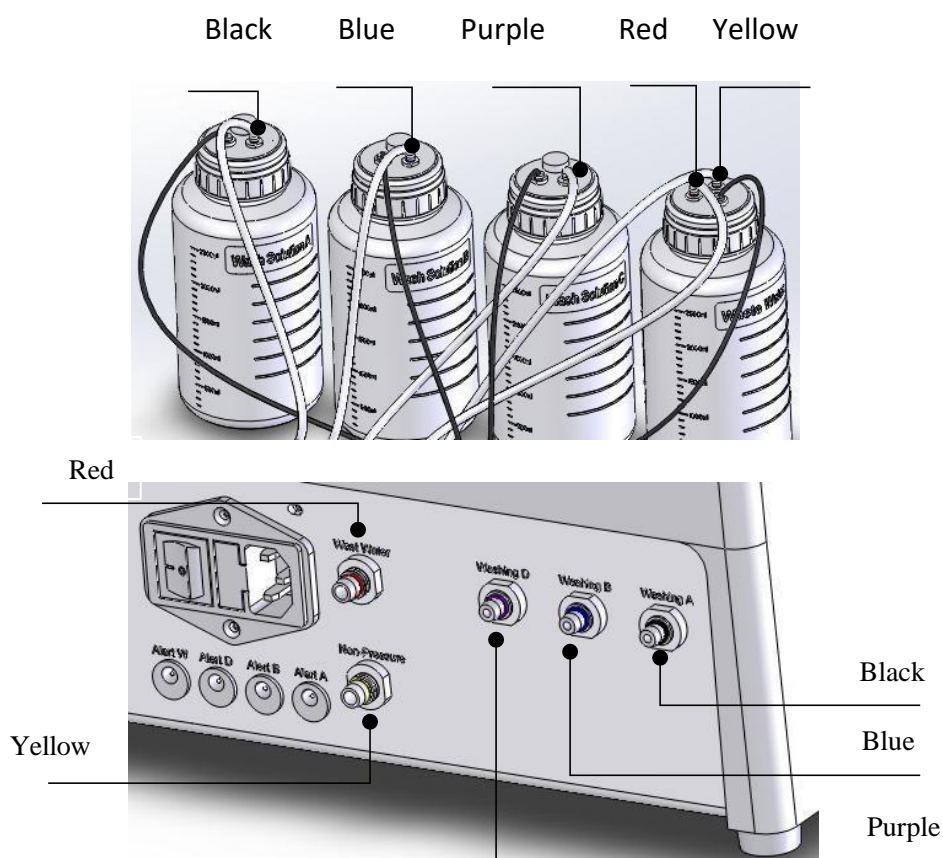

Power supply connection : Connect the Washer to the right power source.

Chapter 5 Software

Main Interface

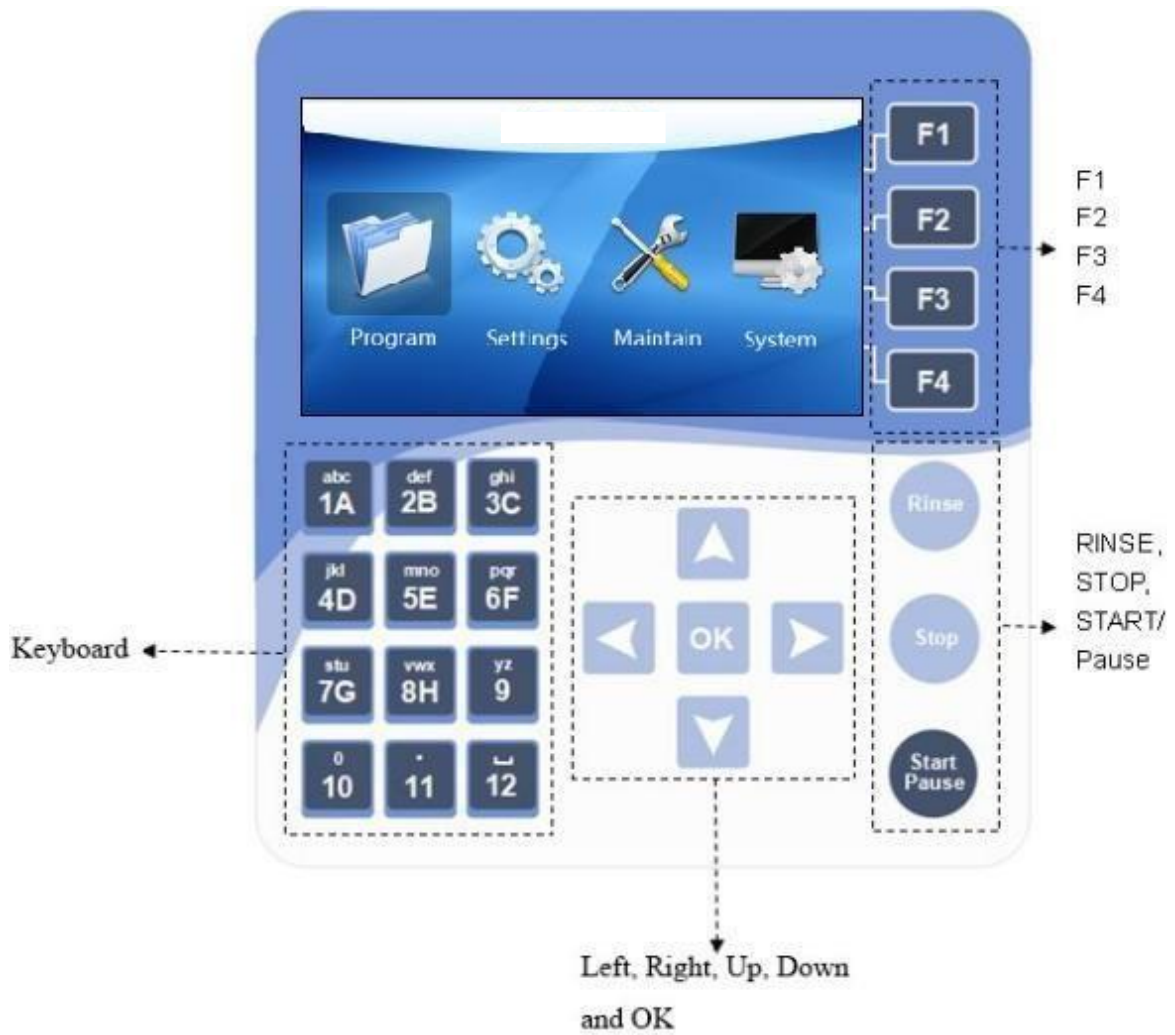

Program menu



Browse with the direction keys.

Push the keys for seconds the cursor would move faster to the direction you choose.



F1,F2, F3 ,F4 are shortcut keys.



Push the start/Pause button in the main menu, it will start to run the program; push again, it will pause the program.



Push Rinse button in "Wash" interface to enter into the wash pipeline program, it will pause if press again. F4 key if for whether cancel this action.



Stop button can make running program stop.

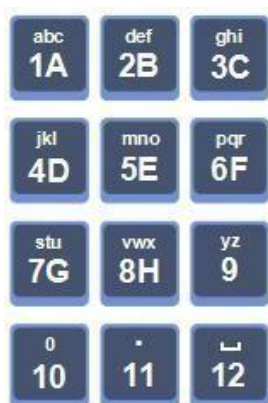

The numbers and letters correspond to the Elisa plate. Push the button once in the main menu, the status would change once. If push over 2 seconds, the rows ahead would be chosen.

Fluid level warning

Warning column shows fluid level status of each bottle (A,B,D and W), the sensor in the bottle can detect fluid level automatically when program running. If the relevant icon turns red, please clear or full the bottle.



Fluid level detection

- Wash solution A,B and D
- When bottles are full, the icon is blue
- When bottles are empty or the sensor is disconnected, the icon is red
- When turn off the sensor in the setting, the icon is yellow

Waste W

- When the waste bottle become full, the icon is red
- When the waste bottle is empty, the icon is blue

Self-inspection

Turn on the power, the system will start self-inspection.

Do not turn off the power, insert the U disk or pull out the U disk.

Do not touch the wash head, wash head rack and the plate box when running.

Please check the connection of bottle W warning and if the bottle W is full there will be a warning interface appeared.

If the wash bottle A,B and D not connected, it will appear similar alert as above when self-inspection.

Check the connection of bottle A,B,D and check if the solution is out. Then push OK or F4 to cancel the warning.



Main menu



- 1. Program:** Choose the program by pushing the UP, DOWN, LEFT,RIGHT buttons and then push OK to confirm.

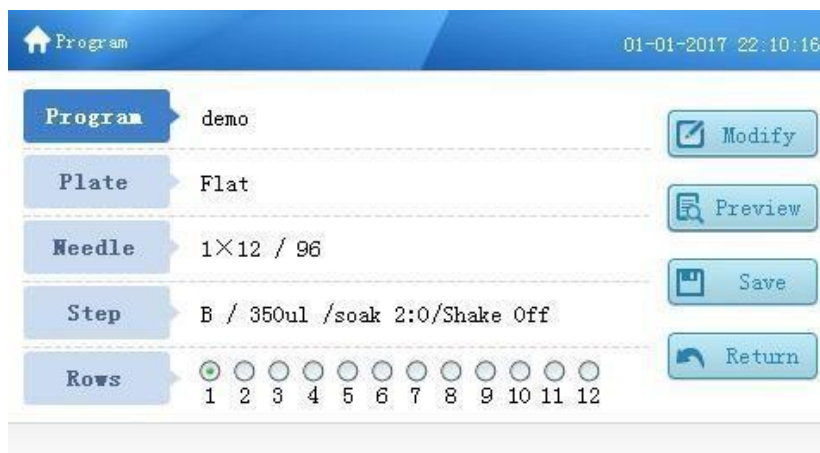

- 2. Setting:** This function includes Pre volume setting, sensor setting, injection index and beeper switch setting.



- Pre volume setting: Choose “Pre volume” in the menu, then press “OK” or F1 button to enter into setting interface. It can set the volume of the solution which will be added in advance, it increases from 5ml to 100ml by 5 ml. The default volume is 50ml.
- Sensor: It can set to turn on/off of the sensor A, B, D.



Attention: Sensor W can not be set as off.

- Injection Index: The range of Injection Index is 0-2.00, set as ± 0.01 each time, the default value is 1.00.
- Beeper switch: It can turn on/off the buzzer.



3. Maintenance: This menu includes wash, 1X8 calibration and 1X12 calibration.



- Wash: Includes scour pipeline, scour pipeline time
- Scour pipeline: It can select bottle A, B and D
- Scour pipeline time range: 00:01-03:59 (mm:ss), default time:2:00.



- 1X8 needles and 1x12 needles wash head calibration:
- User should calibrate the position of wash head before using although it has been calibrated in the factory with standard micro plates.
 - Precision of moving vertically is 0.1mm, so does precision of moving horizontally.
 - When use the 1X8/96 wash head, choose the 1X8/96 in the maintenance menu, then push OK to enter into the calibration interface.
 - 1x12/96 calibration is same as 1x8/96.



Attention! Confirm the wash head before calibration.



Left deviation: Left deviation means the distance between the needle to the left center of the micro plate.

Choose the left deviation function in the calibration menu, then push OK button to enter. Push UP button once, the wash head move left for 0.1mm push down button once, the wash head move right for 0.1mm. Push OK button to confirm and save the setting.

Make sure the wash head needle fit the left center of the micro plate.

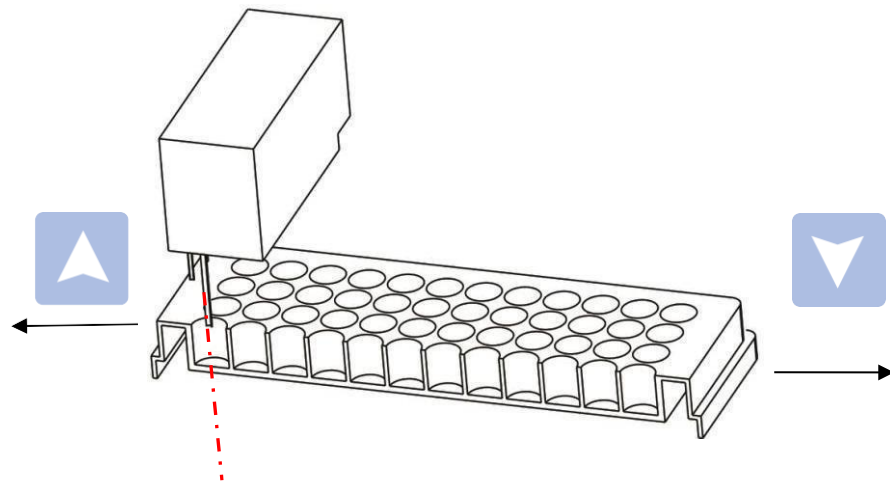

Right deviation: Right deviation means the distance between the needle to the right center of the micro plate. Choose the right deviation function in the calibration menu, then push OK button to enter. Push UP and DOWN to adjust the distance. Push OK button to confirm and save the setting.

Make sure the wash head needle fit the right center of the micro plate.

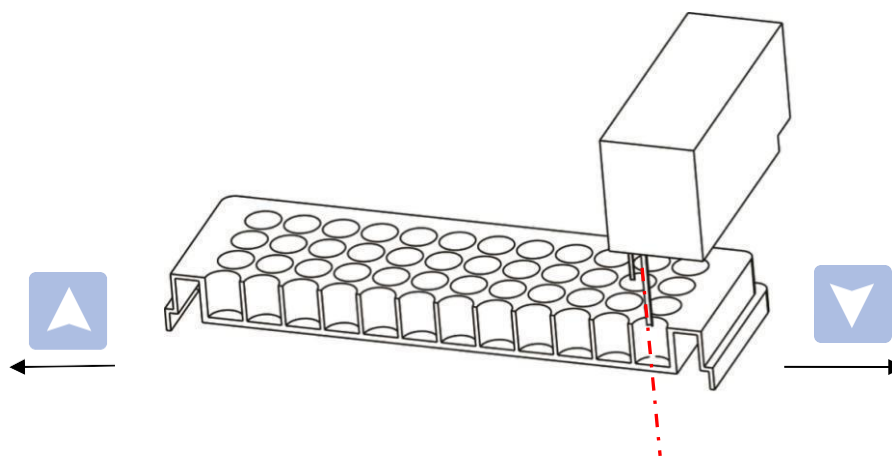

Top deviation means the distance between the wash head bottom to the photoelectric switch.

Choose the top deviation function in the calibration menu, then push OK button to enter. Push UP and DOWN to adjust the distance.

Make sure the distance between the needle bottom to the top of microplate is about 2-3mm.

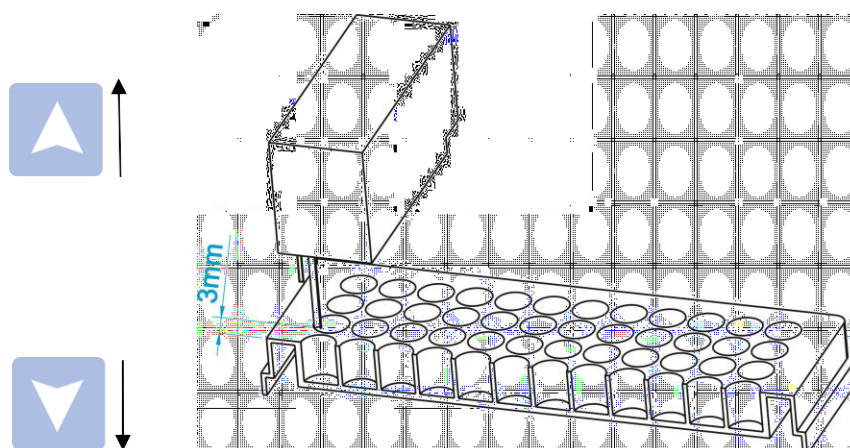

Bottom deviation means the distance between the wash head bottom to the photoelectric switch.

Choose the top deviation function in the calibration menu, then push ok button to enter. Push UP and DOWN to adjust the distance.

Make sure the distance between the needle bottom to the bottom of microplate is about 0.5-1mm.

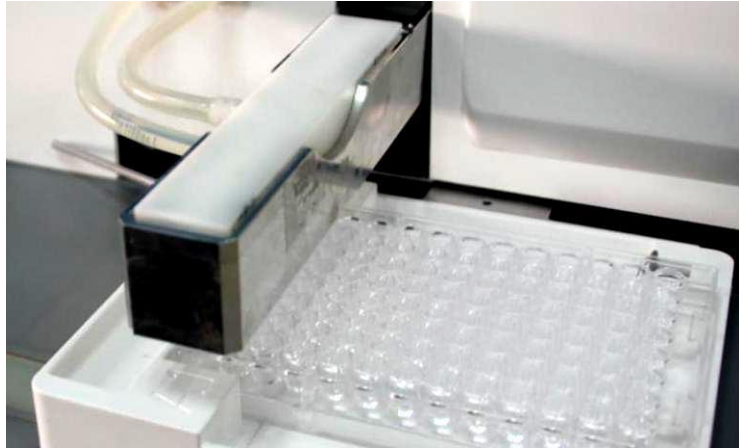

4. System: System menu includes date& time settings, language setting, reset and system upgrade.

Available languages: English and Chinese.



Chapter 6 Wash Program

Wash Program running

Steps to run the wash program:

- Make sure there is enough solution in the bottle A, B and D and Waste
- bottle W is not full before running the program.
- The system will detect the fluid level automatically, please check the tipson the fluid level warning column.
- Program selection: The selected program will be shown on the Programmenu.
- Put the 96 wells plate on the plate box, make sure the position anddirection match with the wash head setting.
- When use the 1×8/96 wash head, the A1 position fits the left up corner and when use the 1×12/96 wash head, theA1 position fits the left down corner.
- Select the row to wash.
- Push Start/Pause button.
- It can stop the program by pushing Stop/F4 button when running.
- Take out the micro plate when wash is over.
- Wash the pipeline.

Fill/wash bottle

Steps to fill and wash bottle:

- Take out the bottle, fill or empty it if necessary.
- Unscrew the cap, fill the solution.
- Screw the cap hard, then connect with the machine.
- Prewash the pipeline before running the program.

Program selection

User can select the program from the list or build a new program, or edit theexisted program. Steps to run the existed program

- Choose the program option, then it appears the following dialog

Program

01-01-2017 22:10:16

Program demo Modify

Plate Flat Preview

Needle 1×12 / 96 Save

Step B / 350ul /soak 2:0/Shake Off Return

Rows 1 2 3 4 5 6 7 8 9 10 11 12

- Choose the program from the list and push OK to confirm

Preview

01-01-2017 22:10:16

Num	Program	Needle	Plate	Adjust Time
1	demo	1×8 / 96	Flat	2017-12-21
2	1	1×8 / 96	Flat	2017-12-21
3	2	1×8 / 96	Flat	2017-12-21
4	3	1×8 / 96	Flat	2017-12-21
5	4	1×8 / 96	Flat	2017-12-21
6	5	1×8 / 96	Flat	2017-12-21

◀ 1/1 ▶

Micro plate installation

The installation direction is relative to the wash head type.

Wash head type and the installation direction sheet.

Wash head type	Plate type	Direction
1X8/96	96 wells	Horizontal
1X12/96	96 wells	Vertical

Put the 96 wells plate on the plate box, make sure the installation direction is correct according to the above sheet. The A1 position of micro plate fit the A1 position of the plate rack.

Pre-wash pipelines

Machine would start to pre-wash the pipeline with the buffer. The solution volume can be set at: setting > pre volume (ul). The default is 20ml. The purpose to pre-wash the pipeline is to fill the solution in the pipeline and wash head. It needs more solution to fill the pipeline when pre-wash at the first time, as the pipeline is empty.

Set the pre-wash volume from 5ml to 100ml in the Settings interface, default volume is 50ml, ± 5 ml per time.

Number button

Rules to use the number buttons

When use 1X8/96 wash head: row 1 to 12, any combination

When use 1X12/96 wash head: row A to H, any combination (relative number from 1 to 8)

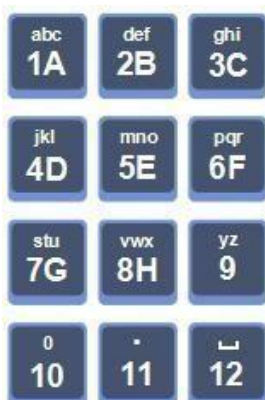

Choose row

Push the relative number to choose or cancel the row.

Push any number for seconds, then all the rows from 1 to the number will be chosen

Cancel running If error happens when running, the machine would stop the program, and appears an error warning. And you can push Stop/F4 to stop the program.

Pre-wash time Push the Rinse button on the panel in the Maintain>Wash interface, the machine would wash the pipeline with the solution in the bottle A, B and D, the time can be set at: Maintenance> wash.
Click “Rinse” button in the program interface, it will enter the Maintenance> wash interface directly.

Chapter 7 Create Wash Program

Create wash program

- Choose the program option, and push OK to enter, the program list will show up.

Program configuration screen showing the following details:

- Program: demo
- Plate: Flat
- Needle: 1×12 / 96
- Step: B / 350ul /soak 2:0/Shake Off
- Rows: 1 2 3 4 5 6 7 8 9 10 11 12

Buttons: Modify, Preview, Save, Return

Click F2 button to enter the Preview interface as below:

Num	Program	Needle	Plate	Adjust Time
1	demo	1×8 / 96	Flat	2017-12-21
2	1	1×8 / 96	Flat	2017-12-21
3	2	1×8 / 96	Flat	2017-12-21
4	3	1×8 / 96	Flat	2017-12-21
5	4	1×8 / 96	Flat	2017-12-21
6	5	1×8 / 96	Flat	2017-12-21

Buttons: New, Delete, Impt&Expt, Return

Page: 1/1

- Push F1 button, the dialog to build the program will show up. Input the programname and push OK button to save or F4 to return.



- Push the OK button on the panel when choose the Plate item, the parameters dialog will show up as below and choose the plate type.

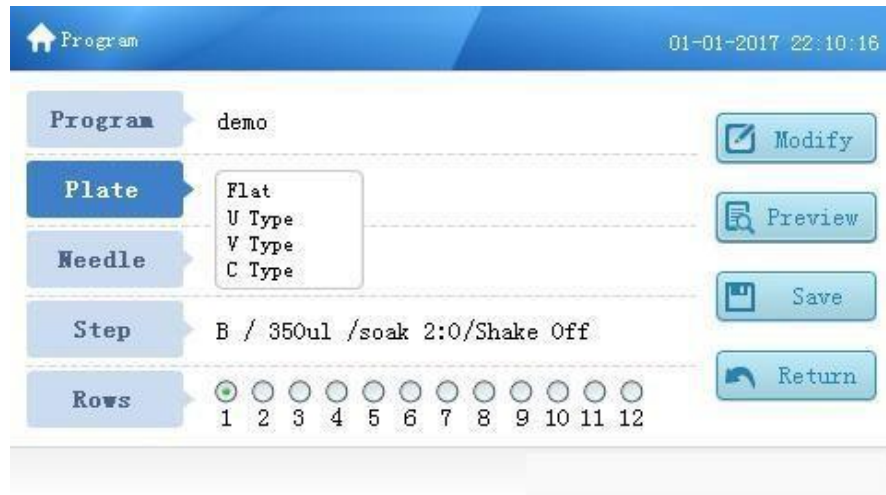

- Push the OK button on the panel when choose the Needle item, the needletype shows as below:

- Push the OK button on the panel when choose the Step item and then enter theStep interface as below:

- Wash Liquid: you can choose the wash liquid from bottle A, B, D or wash, the default value is B.
- Wash Volume(ul):The wash solution volume, from 50 ul to 2000 ul, step by 50ul, the default is 300ul.
- Wash Times: set the wash time, from 1 to 99, the default is 2.
- Immerse Time: The interval time between each wash step. The default is 0, the maximum is 99 min, step by 1 second.
- Vibrate Speed: it can set as off, slow, middle, fast, the default is off. User can only set the vibrate speed when the immerse time is not 0.

Vibrate speed	amplitude	speed
slow	8mm	1Hz
middle	8mm	5Hz
fast	8mm	10Hz



Note: Make sure the solution will not spray out when vibrate

- Wash Mode: it can set the wash mode as plate or row. The default is plate.
- Plate: All rows are completed washing, it will enter into next circle.
- Strip: The selected row was washed with set circle times, then move to the next strip.
- Suction Time: from 0s to 10s, increase by 0.1s. The default is 2. When the absorptiontime is 0s. The machine will be in liquid separation mode, it will only inject the liquid and will no suction anymore.
- Suction mode: it can set as 1 position, 2 positions or 3 positions. The default mode is depending on the plate type.

One position: There is one position in the center.

Two positions: There are two positions in the same line of holes

bottom. Three positions: There are three positions in the same line of holes bottom. Plate type and absorption mode :

Plate type	Suction type		
	One Position	Two Positions	Three Positions
Flat type	Optional	Default	Optional
U type	Default	Not Optional	Not optional
V type	Default	Not Optional	Optional
C type	Default	Not Optional	Not optional

Default: means the default absorption mode when build new program.

Optional: means the optional absorption mode. Usually user is unable to changethe default setting

- Click Number button to choose the strip which need to be washed.
- Click F3 button to save the new program.

Chapter 8 Input, Output and Delete programs

Input program Steps to input the program from the U-disk

- Insert the U-Disk



- Push the F3 button on the panel in the Preview interface, it appears the dialog box.

- Push the F1 button on the panel to enter the import interface, there will be shown at most 100 programs.

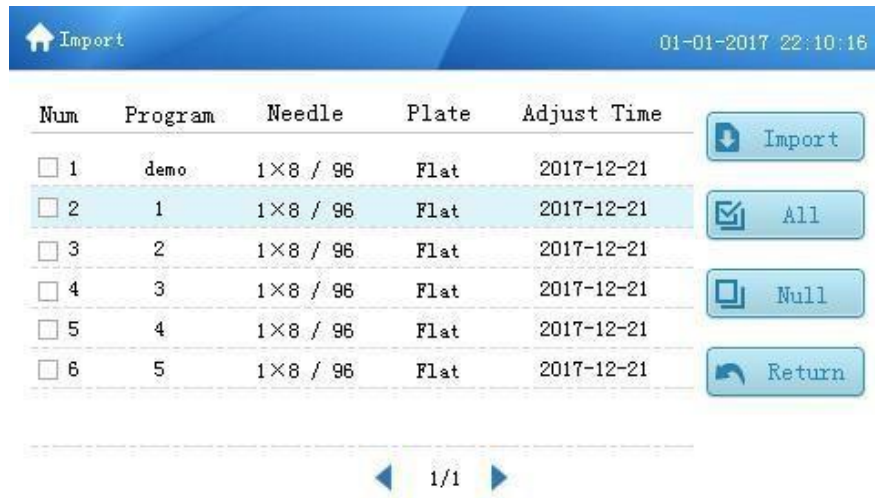

- Choose the program to input, then push F1.

Export program

Steps to export the program to the U disk

- Insert the U disk



- Push the F3 button on the panel in the Preview interface, it appears the dialog box.
- Push the F2 button on the panel to enter the exoort interface, there will be showed at most 100 programs.



The screenshot shows the 'Expert' interface with a blue header bar containing a home icon, the text 'Expert', and the date/time '01-01-2017 22:10:16'. Below the header is a table with columns: Num, Program, Needle, Plate, Adjust Time. The table contains 6 rows of data. To the right of the table are four buttons: 'Export', 'All', 'Null', and 'Return'. Below the table is a pagination control showing '1/1' with left and right arrow buttons.

Num	Program	Needle	Plate	Adjust Time
<input checked="" type="checkbox"/> 1	demo	1×8 / 96	Flat	2017-12-21
<input checked="" type="checkbox"/> 2	1	1×8 / 96	Flat	2017-12-21
<input checked="" type="checkbox"/> 3	2	1×8 / 96	Flat	2017-12-21
<input checked="" type="checkbox"/> 4	3	1×8 / 96	Flat	2017-12-21
<input checked="" type="checkbox"/> 5	4	1×8 / 96	Flat	2017-12-21
<input checked="" type="checkbox"/> 6	5	1×8 / 96	Flat	2017-12-21

- Choose the program to export then push F1.

Delete programs

Steps to delete the program:

- Push the F3 button on the panel in the Preview interface, choose the program you want to delete and then push F2 button to delete. Demo program can not be deleted.

Chapter 9 Power Off

Steps to power off

- Take out the Elisa Plate from the plate box.
- Clear the buffer on the pipeline and wash head with bottle D. Please run the wash program after program over before power offer. If need use the instrument several times, the wash head can be soaked in the solution or water during the interval.

Attention: If the wash head not cleaned, there will be block inside of the wash head. If so, the wash head need be repaired or replaced.

- If the machine will not be used for a long time, please run the pre-wash program to clear the liquid in the pipeline. Take out the pipes from the bottles and run the machine to clear the liquid in the pipelines.
- Turn off the power.
- If the infecting liquid sprayed to the instrument., please sterilize with 70% alcohol.



Warning: Wash head and pre-wash slot may be contaminated once instrument has been used.

Warning: When handle the waste solution, please wear gloves, goggles and protective suit to avoid being infected.

Chapter 10 Maintenance

Maintenance list

- Daily maintenance on pipeline, wash head and plate box.

Pipeline maintenance

- Pipeline maintenance contains pre wash and wash pipeline functions. User can push the Rinse button on the panel to wash the pipeline.

Wash head

- Take out the wash head and the silicone pipeline, detach the seal screws at the side of the wash head, put the wash head to the 75% alcohol. Then dredge the suction needle(long) and the injection needle(short) with the special needle included in the accessories. Suck alcohol with syringe to the pipe and draw back to wash the wash head pipe. Or use the soft brush to clean the inside of the pipe.

Filter net

- Take out the filter net in the bottle, use the injector wash the net with alcohol or use the hairbrush to clean the precipitate.

Plate box

- There is leakage liquid collection tube in the plate box, user can put some distilled water to the platform after use, the liquid will be drawn automatically. Do not let any solid go into the collection pipe, otherwise the collection pipe will be blocked.

Chapter 11 Trouble Shooting

No.	Faulty phenomenon	Possible Causes	Solution
1	No screen light when power on	No power connection	Check the power connection
		Fuse broken	Replace the fuse
		Switch broken	Change the switch
		Screen broken	Contact the distributor
2	Button no reaction	panel broken	Contact the distributor
3	One of the rows liquid remaining over proof	Wash head blocked	clean the wash head with needle
4	Whole plate liquid remaining over proof	Wash head blocked or pipeline aged.	replace the pipe or clean the needle
5	Running with noise	bear broken	contact the distributor
6	wash head touches the plate	position of wash head not correct	calibrate the wash head in setting
7	liquid was injected to the plate box	plate is not positioned correctly.	adjust the direction of the plate
		The wash head is not positioned correctly	Check the wash head, make sure the correct wash head matched the program.
8	no liquid injection or suction	Pump is broken Air pipe is not well connected Solenoid valve broken	Insert the air pipe again , screw the bottle cap tightly, or replace the seal circle.
9	no liquid suction	Pump is broken Air pipe is not well connected Air leakage of the bottles	Insert the air pipe again , screw the bottle cap tightly, or replace the seal circle.
10	Liquid was sprayed to the outside	The liquid is too much or the shake speed is too fast.	reduce the liquid or lower the shake speed

Appendix : Plate washer diagram

