

TABLE OF CONTENTS

1. Introduction	1
2. Intended Use	1
3. Symbol	1
4. Features	1
5. Technical Specification	1
6. Standard Accessories	2
7. Safety Precaution	2
8. Installation	4
9. Standard Parts Listing	6
10. User Interface & Display	6
11. Rotor Installation	7
12. Balancing the Rotor	8
13. Operating the Centrifuge	9
14. Rotor Compatibility	12
15. Maintenance and Cleaning	12
16. Troubleshooting	13
17. Warranty Statement	13
18. Product Disposal	14

1. INTRODUCTION



This is a microprocessor controlled next generation digital Clinical Centrifuge. This centrifuge is designed for the separation and preparation of samples in various applications including in-vitro diagnostic. This product is equipped with maintenance-free Brushless DC motor drive and safety feature of imbalance detection. It comes with 3 different types of rotors (swing and fix) making it compatible with different types of standard sample collection tubes.

2. INTENDED USE

This is a bench top centrifuge which is designed to separate, sediment, spin down aqueous solutions & solvent suspensions of differing densities in compatible sample containers.

NOTE: Before using the centrifuge, please read this user manual carefully. This user manual is intended to assist with the operation and care of the unit & is not a document which aids in repair. For repair please contact the supplier.

3. SYMBOL

 Warning	 Waste electrical
--	--

4. FEATURES

- BLDC motor for maintenance free long life
- Microprocessor controlled: Enables digital variable speed and time setting with last run memory function
- Single instrument for different work protocols with appropriate choice of rotors
- Precise RPM setting from 500 to 4000 RPM with least count of 10 RPM
- Automatic imbalance detection for safe operation
- Lid lock safety - Lid releases (automatically) after run completion
- Compact design with low loading height for ease of operation
- Programming feature: User can save and run upto 99 defined programs (protocols)
- One touch short spin operation & change over from RPM to RCF

5. TECHNICAL SPECIFICATION

Motor Type	BLDC Motor
Speed Setting	500 to 4000 RPM
Speed Accuracy	± 10 RPM
Speed Steps	± 10 RPM
Run Time & Modes	1 to 999 minutes & infinite mode

5. TECHNICAL SPECIFICATION

Dimension (W x D x H)	381 x 480 x 185 (mm)
Weight of the equipment	8.2 kg (without rotor)
Permissible Temp.	5-40°C
Permissible Relative Humidity	≤80%
Altitude	Use upto an altitude of 2000 m above MSL
Pollution Degree	2
Environment	For indoor use only
Noise Level	≤65 dB (A)
Power Adaptor Details	Input: 100-240 VAC, 50/60 Hz Output: 24V \mp 5A
Power Consumption	90 W

Rotor Specification	6 Tubes Rotor		8 Tubes Rotor	16 Tubes Rotor
Rotor	6 x 10ml Swing Rotor		8 x 15ml Fix angle Rotor	16 x 10ml Fix angle Rotor
Maximum Capacity	6 x 2ml, 6 x 3ml, 6 x 4ml	6 x 10ml, 6 x 9ml, 6 x 6ml	8 x 15 ml Conical tube	16 x 10 ml Gel tube
Nominal RCF	1840 g	2270 g	1950 g	2180 g
Acceleration Time	45 second		45 second	45 second
Deceleration Time	40 second		70 second	70 second
Power	90 W		24 W	35 W
Current Consumption	3.7 A		1.01 A	1.45 A

NOTE: Power adaptor may be changed as per subjected of use.

6. STANDARD ACCESSORIES

7. SAFETY PRECAUTIONS



Read all safety & usage information provided in this manual carefully before using the device.

7. SAFETY PRECAUTIONS

- Never use the centrifuge in any manner not specified in this manual.
- Equipment used in any manner not specified in this manual or by the manufacturer can result in the lapse of warranty.
- Never move the centrifuge during its operation.
- The rotor and the rotor only must always be securely fastened. If the centrifuge makes unusual noise during operation, the rotor or the rotor lid fitment needs to be checked. Switch OFF the device immediately by pressing STOP, check fitment & fasten it (if required).
- The rotors must be loaded symmetrically. Each tube should be counter balanced by another tube of same weight.
- Do not use centrifuge or rotor that have not been correctly installed or damaged.
- Repairs must only be performed by authorized service technician.
- Only use recommended original rotors and spare parts for best result & product safety.
- Centrifuge must be used for the specified application only. It must not be operated in a hazardous or flammable environment and must not be used to centrifuge explosive or highly reactive media. Also do not place the potential hazardous material within the clearance area/envelope.
- If liquids are spilled on the rotor or rotor chamber, the centrifuge must be cleaned carefully and properly before being used again.
- Prior to centrifugation, the tubes should be visually inspected for material damage. Damaged tubes must not be used. This is because broken tubes can result in sample loss and in addition can create imbalance which can result in further damage to the centrifuge and its accessories.
- This centrifuges capacity must not be exceeded as it is the maximum capacity.
- Do not lean on the equipment. It may damage the equipment or the harm the operator.
- When moving the centrifuge from a cold room to a normal room, run the centrifuge for 30 minutes beforehand in the cold room to avoid condensation. Alternately, allow it to warm up in lab for at least three hours, but do not plug in the centrifuge in order to prevent possible damage by condensation.
- Be sure to close the tubes lid tightly prior to centrifugation. Open tubes lid can be torn off during centrifugation and can damage the rotor lid or centrifuge.
- Rotor and adapters are high-graded components which are subject to extreme mechanical strain. Even slight scratches and tears can lead to serious internal material damage. Ensure to check rotor for any signs of damage before use. Rotor & rotor lid showing visible signs of corrosion or mechanical damage should not be used.
- Do not fill tubes while they are in the rotor. Liquid spillage may harm the device.

7. SAFETY PRECAUTIONS

- For safety we have provided protective earthing with power supply. Make sure power supply is earthened.
- In the event of contamination caused by aggressive agents, the rotor must be cleaned immediately using a natural cleaning liquid. If any kind of damage is seen kindly contact the service technician.
- Before using cleaning or decontamination method other than those mentioned by the manufacturer, contact the manufacturer to ensure that the intended method will not damage the centrifuge.
- The power adaptor given with centrifuge unit is designed to be used for this particular centrifuge only. Do not use any other power adaptor.

8. INSTALLATION

This bench top clinical centrifuge comes in a packaging box. On receiving the box, gently remove the upper packaging and take out the centrifuge by holding it from the bottom. When centrifuge is used for the first time, ensure that all the packaging accessories are removed from the rotor chamber. The rotor is pre-installed and please make sure that rotor is firmly tightened. Accessories and user manual are kept inside the box with centrifuge. Please keep all the packaging in safe storage for at least 2 years for warranty purpose.

NOTE: Instruction for transportation after delivery to the Responsible Body is based in deal to customer.

The following points are necessary to take care for proper installation:

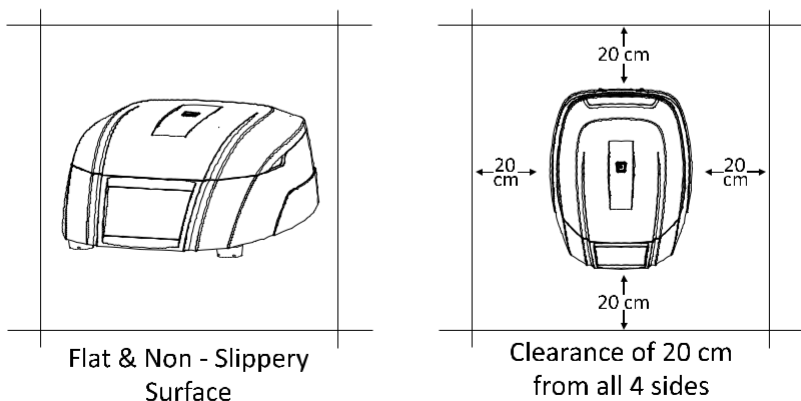

8.1 LOCATION & MOUNTING

Place the centrifuge on a flat and leveled surface; ensure that all the four feet of this

8. INSTALLATION

centrifuge stands on the surface firmly. Avoid installing on a slippery surface or surface prone to vibration.

1. Ideal ambient temperature is $20^{\circ}\text{C} \pm 5^{\circ}\text{C}$; avoid placing the centrifuge in direct sunlight.
2. Keep clearance of at least 20 cm on both sides and at least 20 cm behind it to guarantee the cooling efficiency.
3. Keep away from heat or water to avoid sample temperature issues or centrifuge failures.
4. Do not place the centrifuge so that it become difficult to operate the device.

8.2 CONNECTING POWER ADAPTOR

1. Connect one side of power adaptor to rear side of centrifuge and other to supply as shown in the figure below.
2. Rotate clockwise the adaptor nut to tighten the adaptor with the centrifuge. Ensure the power switch is OFF while connecting the power adaptor.
3. The sticker on the body & jack are indicating the position of the rib on the jack. While fitting the adaptor to the unit-please match the sticker position as shown in the figure below & gently push it in.

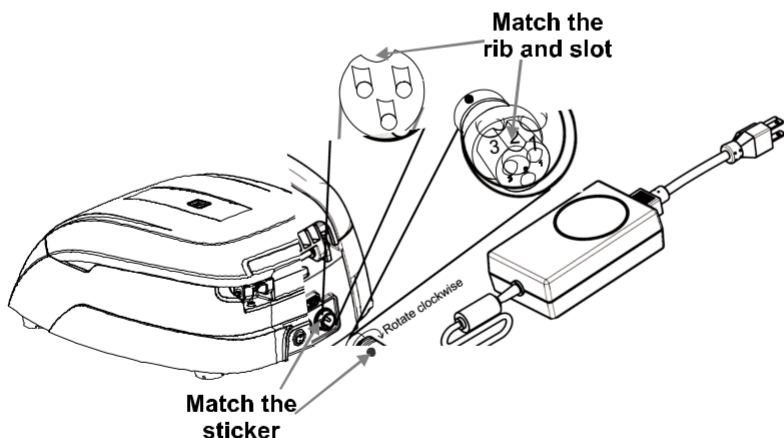

4. If matched correctly the plug will go in easily without much force (do not try to force the plug in if it is not matched properly). Once the plug is inserted into position, turn the loose upper ring clockwise to tighten & to secure the fitment.

9. STANDARD PARTS LISTING

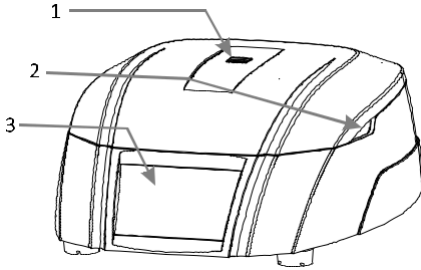

Front View

1. View Window
2. Groove to open the lid
3. Operation and setting Buttons

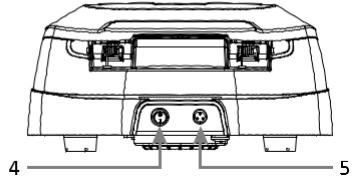

Rear View

4. Power Switch
5. Adaptor Port

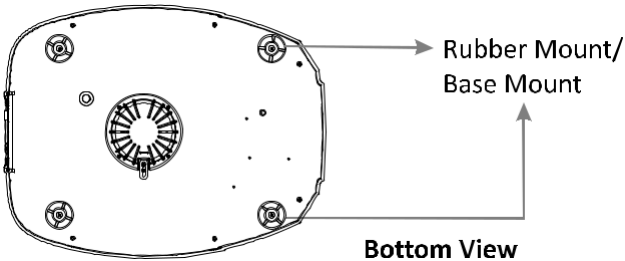

Bottom View

10. USER INTERFACE & DISPLAY

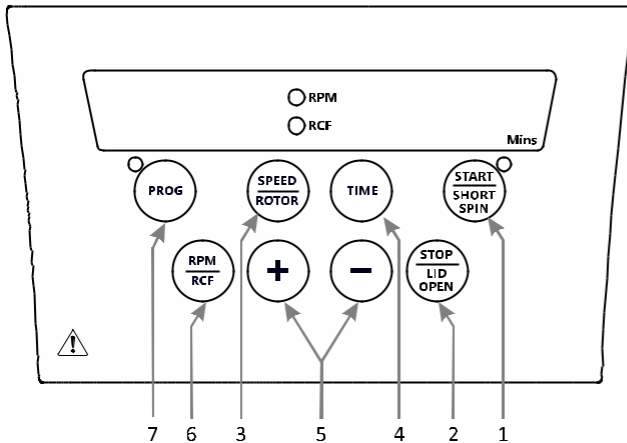

10. USER INTERFACE & DISPLAY

Item	Name	Function
1a	START/ SHORT SPIN	Short press "START" to start the operation of Centrifuge.
1b	START/ SHORT SPIN	Long press "START/SHORT SPIN & hold this button after setting required speed to run centrifuge for short time.
2a	STOP/ OPEN	Press this button to stop the ongoing operation. Lid opens automatically, after rotor comes to a stop.
2b	STOP/ OPEN	Short press this button to open the lid of the centrifuge.
3a	SPEED/ ROTOR	Press this button to select speed value. Then Press "+/-" to set speed value in RPM.
3b	SPEED/ ROTOR	Long press this button to select the rotor.
4	TIME	Press "Time" to select time value. Then press "+/-" to set Time value in minutes.
5	+/-	"+" is used to increase and "-" is used to decrease values.
6	RPM/RCF	Used to toggle display between RPM and RCF.
7	PROGRAM MODE	Long press button to enter in Program Mode and to select any Program out of the 99 available programs.

11. ROTOR INSTALLATION

11.1 ROTOR REMOVING AND REPLACING PROCESS

Upon receiving this centrifuge, its rotor comes pre-installed. In case if user wants to remove or replace rotor, follow the below mentioned procedure :

11.1.1 REMOVING ROTOR

1. Do not try remove or loosen the rotor with bare hands.
2. Using T - Allen Key, loosen the rotor nut by turning it anti-clockwise.

11.1.2 REPLACING ROTOR

1. To replace or install the rotor, take rotor and load vertically on the motor shaft.
2. Place the rotor nut in the center hole of the rotor onto the motor shaft.
3. Put T -Allen Key in rotor nut & turn clockwise to tighten and anticlockwise to loosen rotor.

NOTE: 1) Check the rotor is firmly tightened before running.

11. ROTOR INSTALLATION

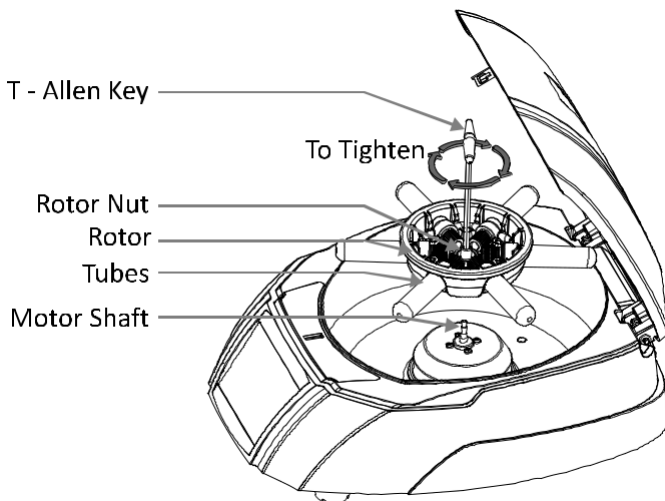

12. BALANCING THE ROTOR

1. Always balance the rotor before beginning the operation. Following are the process of symmetrical loading of centrifuge tubes in the rotor.

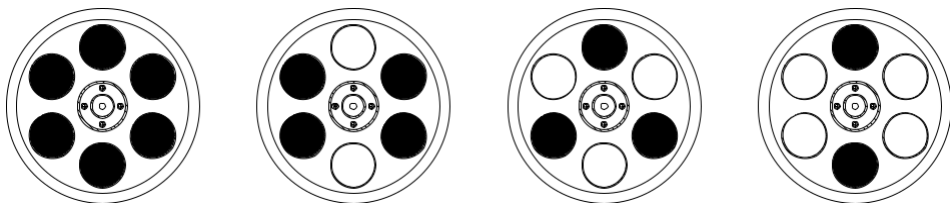

2. The above is the method to load the tubes symmetrically in the rotor. The most important point to remember is that samples in the tubes should be of equal volume.
3. Symmetrical loading of tubes in the rotor is necessary. Otherwise vibration or imbalance can occur which can cause serious damage to the centrifuge.
4. If the tubes are not loaded symmetrically then the imbalance detector will cut off the running centrifuge for device & user safety. This will stop the centrifuge and

12. BALANCING THE ROTOR

Err 55 will be seen indicating tubes are not loaded symmetrically. To resume operation, load tubes symmetrically & restart the centrifuge.

5. This same process is to be followed in case of 8 tubes rotor or 16 tubes rotor.
6. Incorrect method of loading tubes in centrifuge rotor.

13.1 SWITCH ON THE CENTRIFUGE

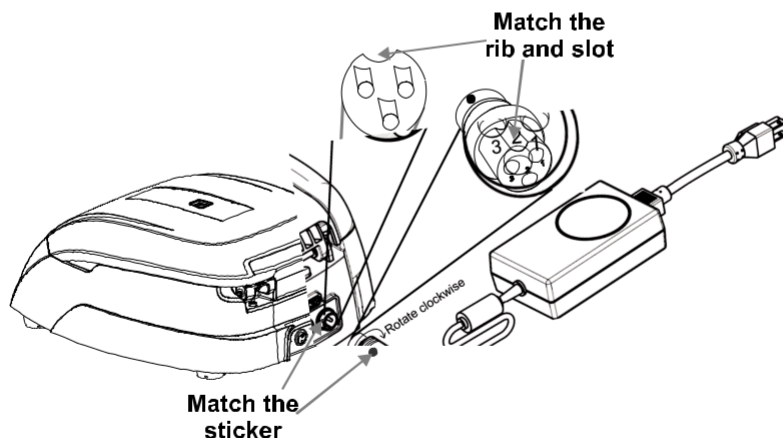

After connecting the power adaptor, switch ON the main power supply & the switch at the rear side of the centrifuge. Make sure to check the rotor fitment before use. Centrifuge will not operate with open lid.

NOTE: Maintain a gap of 3 seconds between switch OFF and switch ON again. DO NOT switch OFF and ON again instantly.

13. OPERATING THE CENTRIFUGE

13.2 SETTING SPEED AND TIME

After closing the centrifuge lid, follow the below mention procedure to set the parameters :

13.2.1 SETTING TIME

The time in the display will show in minutes. The timer set for operation is in between 1min to 999mins and infinite . Infinite time is seen as “] [”. To set time, press “TIME” button and then set the value by pressing “+/-” button. When time button is pressed, the “Mins” display will blink indicating the time value is selected. Once time value is selected, single press “+/-” will increase or decrease time value by 1min. Long press increment or decrement button to quickly increase or decrease time value. Time value gets saved after 5 blinks.

13.2.2 SETTING SPEED

Speed is displayed as RPM. The minimum and maximum speed of Centrifuge is 500 RPM and 4000 RPM respectively. When the equipment is used for the 1st time, the speed will be set to 500 RPM and shown as “500”. Once speed value is selected, single press “+/-” will increase or decrease speed value by 10 RPM. Long press “+/-” to quickly increase or decrease speed value. Speed value get saved after 5 blinks.

13.3 SELECTING THE ROTOR

Long Press “SPEED/ROTOR” to select the rotor number as per the capacity mentioned in the below table.

3 Rotor Options			
Rotor No.	Rotor Type		Max RPM/RCF (x g)
1	Swing out	6 x 10ml	2270
2	Fixed Angle	8 x 15ml	1950
3	Fixed Angle	16 x 10ml	2180

13.4 SWITCHING TO RCF DISPLAY

Press “RPM/RCF BUTTON” to change the mode from RPM to RCF (Relative centrifugal force). After pressing the button the display will show the speed in RCF. Maximum RCF speed of the centrifuge is 2270 x g. The system will automatically convert the values from RPM to RCF and vice versa.

13.5 SHORT SPIN CENTRIFUGATION

Short Spin Centrifugation is the feature for short run. It will run as long as the button is pressed. Set rotational speed prior to short spin as required. During short spin the timer will be in incremental mode.

13. OPERATING THE CENTRIFUGE

This feature can be activated upon long press of “START/SHORT SPIN” button. After releasing short spin button the time in the display will show duration of short spin.

13.6 PROGRAM MODE

Program mode operation is the feature which allows user to save 99 programs which can have different speed and time parameters. User can use any of these program simply by turning ON the program mode. To turn ON the program mode, Long press “PROG” button and then display will blink and show “P01” indicating program mode is activated. User can select any program from “P01 to P99” by pressing “+/-” when the program display is blinking. Once required program is selected, press “Speed” to select and set speed value, press “Time” to select and set time value.

Once all values are set, display will blink 5 times and after that all the selected values of different parameters will get saved in respective program. If user wants to set another program while the display is blinking, press “+/-” to move to the next program and set the values in next program. If user wants to modify previously saved program then short press the “PROG” and then select the program which user wants to modify by pressing “+/-”.

Now the selected program will show previously saved values of parameters. User can change the values of parameters as per need, once all parameters are fed the program will be saved automatically with new values after the ACTUAL display showing the selected program number blinks for 5 times.

13.7 OPENING CENTRIFUGE LID IN POWER FAILURE

Disconnect the centrifuge from the main supply. Wait until the rotor comes to a standstill (this may take some time). Once the rotor has stopped, use the T-allene key from bottom side of the unit, rotate the T-allen key in counterclockwise direction as indicated in above figure this will open the centrifuge lid in case of emergency lid opening.

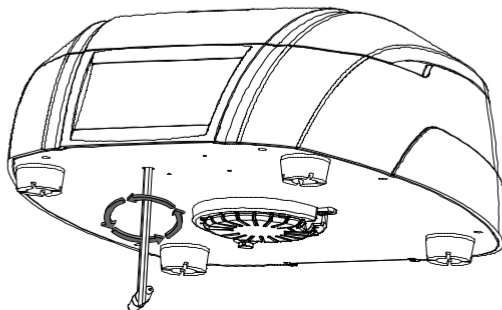

13. OPERATING THE CENTRIFUGE

13.8 IMBALANCE DETECTION

The centrifuge is equipped with an imbalance detection safety feature. When the rotor is not loaded symmetrically, the imbalance detector gets activated and will cut off the centrifugation. The error "Err 55" will be shown on the display. First correct the imbalance load using method described in the balancing the rotor section (page no. 10) of this manual. After correcting the imbalance, switch OFF & switch it ON again. The values will be same as set before imbalance. The imbalance detection feature cannot be deactivated, as it is factory fitted.

14. ROTOR COMPATIBILITY

This centrifuge is compatible with 3 rotors that user can choose from. Each rotor has different radius and so corresponding RCF would also be different. When user operates a particular rotor, user has to select the rotor number for that particular RCF. Rotor selection is mentioned in the section 13.3.

The details of the rotors are mentioned in page number 02.

15. MAINTENANCE AND CLEANING

- The rotor and the outside of the centrifuge should be cleaned regularly with a mild wet (with water) cloth.
- Ensure that while cleaning the unit is not plugging in.
- Wear protective glove & safety glass while operating & cleaning the device.
- The brushless motor in the centrifuge requires no routine maintenance. Any required service should be performed by authorized, qualified personnel only. Repairs performed by unauthorized personnel may void the warranty.
- Always keep the centrifuge housing, rotor chamber and rotor clean. All parts should be wiped down periodically with a soft cloth. For more thorough cleaning, use a neutral cleaning agent (Ph between 6 and 8) and clean with a soft cloth. Exclusive amounts of liquid should be avoided.

NOTE: Liquid should not come into contact with the motor.

- After cleaning, ensure that all parts are dry before re-use.
- Regularly cleaning of the rotor is important.
- If the rotor chamber needs cleaning, clean with cloth or sponge moistened with a neutral detergent solution.
- Do not place the rotor into the cleaning solution.
- If corrosive, toxic or pathogenic bacteria are accidentally spilled in the rotor or rotor chamber the centrifuge must be decontaminated throughly.

16. TROUBLESHOOTING

This centrifuge has a self – diagnostic function. If a problem occurs, an error/warning code will be displayed on the display screen and the operator can determine the malfunction with the warning code below.

ERROR	PROBLEM	SOLUTION
No display	No main power connection	Check power & properly plugin power adaptor at both ends
	Power failure	Check the main fuse of the lab.
	Improper connection	Connect adaptor properly
Err 1	Lid not close perfectly	After the error 01 please do power off and then power on. After that use the emergency lid through the allen key on the clockwise rotation.
Lid Open	If lid is closed and display shows "lid open" then rotor will not operate	Make power off and then power on. Press lid open button for 2 or 3 times
Err 55	Rotor not loaded symmetrically	Load the rotor symmetrically & restart the centrifuge
Centrifuge lid cannot be opened	Rotor is still spinning	Wait for the rotor to come to a stop
	Power failure	Rotate allen key for lid release after rotor stops
Centrifuge shakes during acceleration & makes loud running noises while running	Rotor is not loaded symmetrically	Load rotor symmetrically & restart operation
	Either a broken tube, damage to the rotor or motor is the cause for run noise	Replace broken tube. For damaged rotor/motor contact a service representative
	Rotor is damaged	Remove & change rotor
Err 52	Rotor is Stuck	Turn OFF the centrifuge, Check & fit the rotor properly & turn ON the centrifuge

NOTE: 1) If the centrifuge is working slow or hot due to overdraw current, restart the centrifuge and check it again.

2) Do not use liquid with density higher than 1.2g/ml for full load operation.

17. WARRANTY STATEMENT

This product is warranted to be free from defects in material and workmanship for a period of two (2) years from date of purchase. Your product will be duly repaired upon prompt notification in compliance with the following conditions :

17. WARRANTY STATEMENT

This warranty is valid only if the product is used for its intended purpose and within the guidelines specified in this instruction manual. This warranty does not cover damage caused by accident, neglect, misuse, improper service, natural forces or other causes not arising from defects in original material or workmanship. This warranty does not cover any incidental or consequential damages, commercial loss or any other damages from the use of this product.

The warranty is invalidated by any non-factory modification, which will immediately terminate all liabilities on us for the products or damages caused by its use. The buyer and its customer shall be responsible for the product or use of products as well as any supervision required for safety. If requested the products must be returned to the distributor in well packed and insured manner and all shipping charges must be paid.

Some states do not allow limitation on the length of implied warranties or the exclusion or limitation of incidental or consequential damages. This warranty gives you specific legal rights. This warranty is given expressly in lieu of all other warranties, expressed or implied.

The purchaser agrees that there is no warranty of merchantability or of fitness for any intended purpose and that there are no other remedies or warranties, expressed or implied, which extend beyond the description on the face of the agreement. This warranty is only applicable to the original purchaser.

Products received without proper authorization will not be entertained. All items returned for service should be sent postage prepaid in the original packaging or other suitable carton, padded to avoid damage. We will not be responsible for damage incurred by improper packaging.

All items returned for service should be set postage prepaid in the original packaging or other suitable carton, added to avoid damage. This warranty is valid only if the warranty is registered with the supplier within 30 days from the date of purchase.

For your reference, make a note of serial number, date of purchase and supplier here.

Serial No.:

Purchase Date:

Supplier:

18. PRODUCT DISPOSAL

In case the product is to be disposed of, the relevant legal regulations are to be observed.

Information on the disposal of electrical and electronic devices in the European

18. PRODUCT DISPOSAL

Community

The disposal of electrical devices is regulated within the European Community by national regulations based on EU Directive 2012/19/EU on waste electrical and electronic equipment (WEEE). According to these regulations, any devices supplied after 13.06.05 in the business to business sphere, to which this product is assigned, may no longer be disposed off in municipal or domestic waste. They are marked with the following symbol to indicate this.

As disposal regulations within the EU may vary from country to country, please contact your supplier if necessary.

