



# Life Science Products Catalog



Biocomma Limited Huizhou Production Base



# Company Profile

Biocomma, established in 2006 with its headquarters in Shenzhen, is dedicated to the research, production, and distribution of life science and medical health products. Operating in over 50 countries and regions, the company offers sample preparation solutions for food and clinical testing, including filtration consumables, chromatography consumables, and microbial culture media.

Biocomma also provides products such as filters, swabs, reagent bottles, sterile buffers, and culture media for life science research and manufacturing companies. Our mission is to contribute to a healthier and better world.

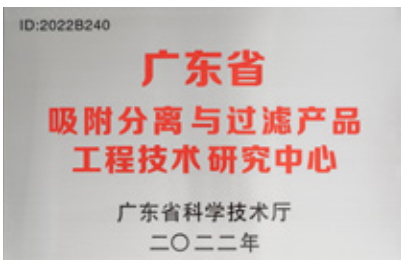

Guangdong Adsorption, Separation, and Filtration Materials Engineering Center Certification

Biocomma Limited collaborates with 9 peer companies and Hanshan Normal University to establish the College of Resources, Environment, and Green Manufacturing Industries.



# Contents

## 1

### Nucleic Acid purification Products & Accessories

■ Technical & Production Advantages .....	7
<b>I. Hot Seller</b>	
■ NP Series: Plasmid, Genomic DNA Spin Column .....	8
■ RP Series: RNA Purification .....	9
■ HP Series: High-Yield Purification .....	9
■ MP Series: cfDNA, Methylation Purification .....	10
■ EP Series: Large Volume Purification .....	10
■ Anion-Exchange Column .....	11
■ High-Throughput Extraction Plates .....	11
■ 96 -Well Filtration Plate .....	12
■ Empty Spin Columns with Filters .....	13
■ Filtration Cartridges with Plunger .....	13
■ Lysis-Filtration Columns .....	13
<b>II. Accessories of Spin Column</b>	
■ Empty Spin Columns & Collection Tubes .....	14
■ Fix Rings .....	14
■ Silica Membrane .....	14
■ PE Porous Sheet .....	15
■ Support Filter .....	15
■ OEM/ODM Service .....	15
<b>III. Validation Data</b>	
■ Yield and Purity of Spin Columns .....	16
■ Stability of Spin Columns .....	16
■ Purity Testing of Silica Membrane .....	16
<b>IV. Other Accessories</b>	
■ Magnetic Beads .....	17
■ Tip Combs .....	17
■ Reagent Bottles .....	17
■ Proteinase K .....	18
■ Grinding Tubes .....	18
■ Cryogenic Vials .....	18

## 2

### Oligo Synthesis Solution

■ Embed™ Technology .....	20
<b>I. CPG Frits Synthesis Columns</b> .....	21
<b>II. Traditional Oligo Synthesis Columns</b> .....	22
<b>III. Synthesis Plates</b>	

■ 384-Well Synthesis Plates .....	23
■ 96-Well Synthesis Plates .....	24

### IV. Desalting Purification Cartridges & Plates

■ RPC Cartridges & Plates .....	25
■ C18 Cartridges & Plates .....	25
■ G25 Desalting Purification Cartridges .....	25
<b>V. Empty Columns &amp; Plates with Frits</b> .....	26
■ Empty Rimless Solid Phase Synthesis Columns .....	27
■ Dvfree™ Empty Multi-Well Plates .....	27
■ Frits for Oligo Synthesis Columns .....	27

### VI. Family Products

■ Solvent Filter .....	28
■ Molecular Sieve .....	28
■ Phosphoramidites .....	28
■ Universal CPG .....	29
■ Dyes & Quenchers .....	29
■ DNA/RNA Monomers & Modifiers .....	29

## 3

### Proteomics

■ Protein Purification Prepacked Columns .....	31
■ GICA Optimizer .....	32
■ Prestained Protein Ladder .....	32
■ Frits for Affinity Chromatography (AC) Columns .....	33
■ Empty Luer-Inlet AC Columns .....	33
■ Empty Affinity Chromatography (AC) Columns .....	34
■ Empty Affinity Chromatography (AC) Column Kits .....	34
■ Empty FPLC Columns .....	35
■ Empty Screw Cap Spin Columns .....	36
■ Empty Micro-spin Chromatography Columns .....	37
■ Empty Spin Chromatography Columns .....	37

## 4

### Bioprocess

■ Erlenmeyer Flasks .....	39
■ Aseptic Transfer Caps for Erlenmeyer Flask .....	41
■ Square Media Bottles .....	42
■ Dry Blend Buffered Packs .....	43
■ Biological Buffers .....	43



## 5 Laboratory Filtration Consumables

▪ UHMW-PE Frits.....	45
▪ Hydrophobic Frits.....	48
▪ Hydrophilic Frits.....	49
▪ Polypropylene Fiber Frits.....	50
▪ Filtration Cartridges.....	50
▪ Paper Filters.....	51
▪ Empty Straight-Barrel Tubes.....	51
▪ Empty Luer-Inlet Tubes.....	52
▪ Empty Rimless Tubes.....	52
▪ Connectors.....	52
▪ Flow Regulators.....	53
▪ Upper and Bottom Caps.....	53
▪ Micro Centrifugal Filters.....	54
▪ 24-Well Micro-Filter Plates.....	54
▪ 96-Well Micro-Filter Plates.....	55
▪ Microfiltration Membranes.....	56
▪ Syringe Filters.....	57
▪ Sterile Syringe Filters.....	58
▪ Sterile Filter Device.....	59

## 6 General Laboratory Consumables

▪ Collection Plates.....	61
▪ Silicone Sealing Mats.....	62
▪ Sealing Films.....	62
▪ Reagent Reservoirs.....	62
▪ Centrifuge Tubes.....	62
▪ PCR Tube/Plate.....	63
▪ ELISA Microplates.....	64
▪ Cell Culture Dishes.....	64

## 7 Laboratory Equipment

▪ Nucleic Acid Extraction System.....	66
▪ Automated Sample Preparation System.....	67
▪ Multifunctional Vortex Mixer.....	68
▪ Solid Phase Extraction Vacuum Manifolds.....	68
▪ Vacuum Manifolds.....	69
▪ 96-Well Plate Nitrogen Evaporator.....	70
▪ Positive Pressure 96 Processor.....	71
▪ Heat Sealer.....	72
▪ Noiseless Ultrasonic Cleaner.....	72
▪ Manual Pipettes.....	73
▪ Bottletop Dispensers.....	73

## 8 OEM & ODM

### Empower Your Brand with Our Manufacturing

▪ Filters & Frits.....	75
▪ Precision Injection.....	75
▪ Biological Buffers.....	75
▪ Logo Printing.....	75
▪ ODM.....	75



# Nucleic Acid Purification Products & Accessories

# 01



# Technical & Production Advantages

## Technical Capacity

Biocomma has established an integrated industry-research base in collaboration with the Shanghai Institute of Organic Chemistry, Chinese Academy of Sciences, and the College of Materials Science and Engineering at Shenzhen University. It has developed a technology innovation platform and industrialization platform with a core focus on polymer filtration materials, adsorption separation materials, membrane materials, and sterile liquids. Furthermore, we have established the Guangdong Province Engineering Technology Research Center for Adsorption, Separation, and Filtration Products.

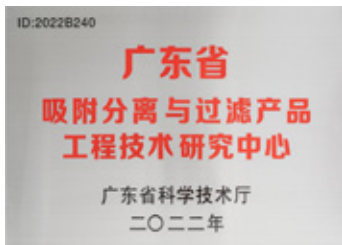

## End-to-End Production Capacity

Raw material screening (LC/MS, GC/MS), in-house mold development and injection molding, and self-production of silica membranes. We have passed ISO 9001:2015 quality management system certification, ensuring quality control from the source.



# I. Hot Seller

## NP Series: Plasmid, Genomic DNA Spin Column

Biocomma's NP series consists of spin columns and collection tubes. The nucleic acid adsorption membrane within the spin columns is made of specific silica-based materials, offering excellent flow rate, strong DNA binding capacity, and outstanding elution efficiency. It is suitable for PCR purification product recovery, DNA gel recovery, genomic DNA extraction from various sample types, including animal tissues, formalin-fixed tissues, bacteria, plants, soil, fungi, yeast, clinical samples (blood, urine, feces), etc.

### Features:

- Spin columns and silica membrane are made in-house, efficient cost control
- Professional R&D Center, proceed function validation for each lot
- Automatic production and inventory management ensure fast delivery
- Applied to gel recovery, PCR purification, genomic DNA extraction, plasmid preparation, ect.



### Ordering Information

Cat. #	Description	Volume	Yield	Qty.
NP05	biocomma® DNA Cleanup & Gel Purification Columns, Mini spin columns, capless spin columns, white fixing rings	2 mL, 800 µL	~10 µg	500 Pcs/PK
NP10	biocomma® DNA Cleanup & Gel Purification Columns, Mini spin columns, capless spin columns, yellow fixing rings	2 mL, 800 µL	~10 µg	500 Pcs/PK
NP10-A	biocomma® DNA Cleanup & Gel Purification Columns, Mini spin columns, capped spin columns, yellow fixing rings	2 mL, 800 µL	~10 µg	500 Pcs/PK
NP20	biocomma® Genomic DNA Extraction Columns, capless spin columns, green fixing rings	2 mL, 800 µL	~20 µg	500 Pcs/PK
NP20-A	biocomma® Genomic DNA Extraction Columns, capless spin columns, green fixing rings	2 mL, 800 µL	~20 µg	500 Pcs/PK
NP30	biocomma® Plasmid Miniprep Columns, capless spin columns, blue fixing rings	2 mL, 800 µL	~30 µg	500 Pcs/PK
NP30-A	biocomma® Plasmid Miniprep Columns, capped spin columns, blue fixing rings	2 mL, 800 µL	~30 µg	500 Pcs/PK
NP100	biocomma® Plasmid Midiprep Columns	15 mL, 4 mL	~100 µg	50 Pcs/PK
NP500	biocomma® Plasmid Maxiprep Columns	50 mL, 22 mL	~500 µg	20 Pcs/PK



## RP Series: RNA Purification

Biocomma's RP series consists of spin columns and collection tubes. The nucleic acid adsorption membrane within the spin columns is made of specific silica-based materials, and it undergoes a special RNA enzyme treatment, providing exceptionally strong RNA binding capability and outstanding elution efficiency. This series is suitable for RNA extraction from various sample types, including animal tissues, plant tissues, soil, fresh large fungi, nucleated anticoagulated blood, coagulated blood samples, yeast cell suspensions, etc.



### Ordering Information

Cat. #	Description	Volume	Yield	Qty.
RP20	biocomma® RNA Extraction Columns, capless spin columns, green fixing rings	2 mL, 800 µL	~10 µg	500 Pcs/PK
RP20-A	biocomma® RNA Extraction Columns, capped spin columns, green fixing rings	2 mL, 800 µL	~10 µg	500 Pcs/PK

## HP Series: High-Yield Purification

Biocomma's HP series consists of spin columns and collection tubes. The nucleic acid adsorption membrane inside the spin columns is a silica-based material that has undergone high-loading process treatment, resulting in superior DNA/RNA binding capabilities compared to conventional silica membranes, typically 1.5–2.0 times better. It is suitable for DNA/RNA extraction from various sample types, including plasmids, animal tissues, plant tissues, soil, fungi, clinical samples (such as blood, urine, feces, bloodstains, etc.), and yeast cell suspensions.



### Features:

- Strong binding capacity: the single-layer membrane loading is 1.5–2.0 times that of normal membranes
- High purity: the OD260/OD280 ratio is typically 1.7–1.9

### Ordering Information

Cat. #	Description	Volume	Yield	Qty.
HP50	biocomma® Plasmid Miniprep Columns, Large-Scale, capless spin columns, White fixing rings	2 mL, 800 µL	55 µg	500 Pcs/PK
HP50-A	biocomma® Plasmid Miniprep Columns, Large-Scale, capped spin columns, white fixing rings	2 mL, 800 µL	55 µg	500 Pcs/PK
HP200	biocomma® High-yield Plasmid Maxiprep Columns	15 mL, 4 mL	200 µg	50 Pcs/PK
HP1000	biocomma® High-yield Plasmid Maxiprep Columns	50 mL, 22mL	800–1000 µg	20 Pcs/PK
HP1000-P	biocomma® High-yield Plasmid Maxiprep Columns	50 mL, 22mL	1–1.5 mg	20 Pcs/PK

## MP Series: cfDNA, Methylation Purification

Biocomma's MP series consists of spin columns and collection tubes. The nucleic acid adsorption membrane within the spin columns is made of specific silica-based materials, offering excellent flow rate, strong DNA binding capacity, and outstanding elution efficiency. Suitable for cfDNA and oligonucleotide purification, especially ideal for the purification of small fragment-labeled probes, capable of removing single-stranded DNA fragments below 10 bases, enzymes, salts, and non-incorporated radiolabeled biotin or digoxigenin-labeled nucleotides.

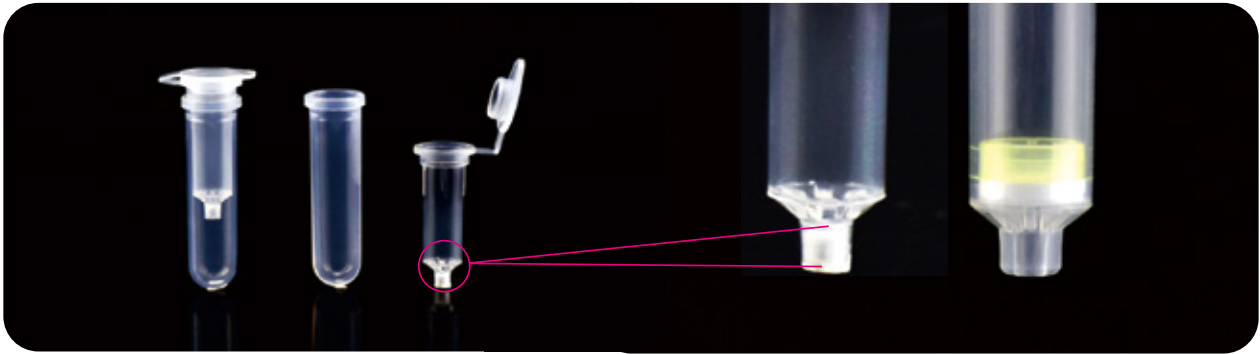

### Ordering Information

Cat. #	Description	Volume	Yield	Qty.
MP05	biocomma® Micro-Scale DNA Purification Columns	2 mL, 800 µL	~5 µg	500 Pcs/PK

## EP Series: Large Volume Purification

biocomma® Large-Volume Purification Columns are supplied with spin columns, extension tubes, connectors and collection tubes. The columns allow large sample volume and normal elution volume.

### Features:

- Large sample volume to improve experimental efficiency
- Reduce sampling times and easy to operate
- Options: columns can connect with vacuum manifold

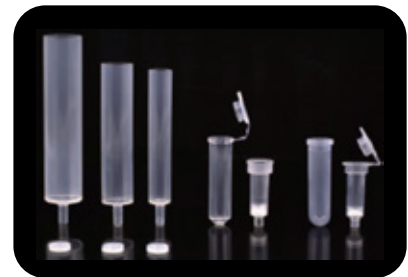

### Ordering Information

Cat. #	Description	Volume	Qty.
EP05-06	biocomma® Large-Volume Spin Columns, 6 mL extension tubes, capless Mini spin columns	5 ~10 µg	500 Pcs/PK
EP05-12	biocomma® Large-Volume Spin Columns, 12 mL extension tubes, capless Mini spin columns	5 ~10 µg	500 Pcs/PK
EP05-25	biocomma® Large-Volume Spin Columns, 25 mL extension tubes, capless Mini spin columns	5 ~10 µg	50 Pcs/PK
EP50-03A	biocomma® Large-Volume Plasmid Miniprep Columns, 3 mL extension tubes, capped spin columns, white fixing ring	60 µg	50 Pcs/PK
EP50-06A	biocomma® Large-Volume Plasmid Miniprep Columns, 6 mL extension tubes, capped spin columns, white fixing ring	80 µg	50 Pcs/PK
EP50-12A	biocomma® Large-Volume Plasmid Miniprep Columns, 12 mL extension tubes, capped spin columns, white fixing ring	120 µg	50 Pcs/PK



## Anion-Exchange Column

Biocomma's Plasmid preparation Columns are based on Biocomma's anion-exchange chromatography. The resins are composed of small particles with a uniform particle, to provide high yields and reproducible performance. Extracted plasmid is ready to use in many downstream applications, including sequencing, library construction, transcription, transfection.

### Features:

- High yield: direct isopropanol precipitation can yield up to 10mg of plasmid DNA
- High purity: used in compatible reagent kits, it has an endotoxin content of less than 0.1 EU/mL, meeting the requirements of most transfection experiments
- Widely applicable: suitable for molecular biology experiments such as restriction digestion, PCR, transformation, sequencing, and transfection

### Ordering Information

Cat. #	Description	Volume	Yield	Qty.
RS30-1	biocomma® Plasmid Maxiprep Columns	30 mL	300-600 µg	20 Pcs/PK
RS30-2	biocomma® Plasmid Maxiprep Columns	30 mL	500-1000 µg	20 Pcs/PK
RS300-22	biocomma® Plasmid Megaprep Columns	300 mL	5-10 mg	10 Pcs/PK
RS2401-2	biocomma® Plasmid Extraction plate	15 mL/well	300-500 µg/well	1 Pc/PK
Custom columns				

Note: 80-120 mL and 600-1000 mL bacteria culture are recommended for expected yield of 500-1000 µg and 5-10 mg by RS30-2 and RS300-22 respectively.



## High-Throughput Extraction Plates

The membrane in the nucleic acid extraction plate is made of specific silica-based material, which offers excellent flow rate, strong DNA binding capacity, and exceptional elution efficiency. It can be used for plasmid extraction, PCR purification, DNA gel recovery, genomic DNA extraction from various sample types, including animal tissues, formalin-fixed tissues, bacteria, plants, soil, clinical samples, fungi, yeast, and so on.

### Features:

- Complete specifications: 24 well (15mL/well), 96 well (1ml or 1.5mL/well) and 384 well (150µL/well) plates
- Corresponding collection plates and vacuum & positive manifolds are available
- Special mold design to avoid cross-contamination

### Ordering Information

Cat. #	Description	Volume	Yield	Qty.
DNAK9602-N	96-well Extraction Plates, Full-Skirted	1.0 mL/well	~15 µg/well	4 Pcs/PK
DNAK9607-N	96-well Extraction Plates, Semi-Skirted, clear fixing ring	1.5 mL/well	~15 µg/well	4 Pcs/PK
DANK9607-G	96-well Extraction Plates, Semi-Skirted, clear fixing ring	1.5 mL/well	~20 µg/well	4 Pcs/PK
DANK3840	384-well Extraction Plates	150µL/well	~500 ng/well	4 Pcs/PK

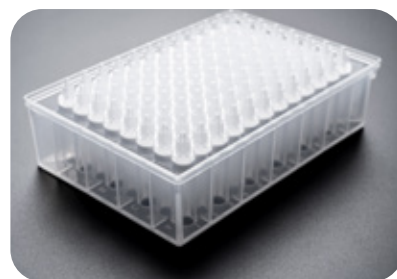

Distributed by:

CliniSciences Group

## 96 -Well Filtration Plate

biocomma® 96-well filtration plate is designed for high-throughput sample processing. It is injection-molded from medical-grade PP, and the filter screens are precision-sintered from uniform particle size UHMW-PE. Filter with different pore sizes are available to meet the filtration of complex samples.

### Features:

- Designed for filtering viscous samples like bacterial liquids
- Suitable for filtering at the micrometer level and above
- Can be used in conjunction with negative pressure or centrifugation
- Compatible microplate collection plates
- Conform to ANSI/SBS standards for ease of automation



### Ordering Information

Cat. #	Description	Qty.
004905-1	96 -well filtration plates, 1.0 mL/well, for viscous sample	30 Pcs/PK
004905-4	96 -well filtration plates, 1.5 mL/well, for viscous sample	30 Pcs/PK
004901-5	96 -well filtration plates, 1.0 mL/well, 5 µm frit/well	2 Pcs/PK
004901-20	96 -well filtration plates, 1.0 mL/well, 20 µm frit/well	2 Pcs/PK
004901-50	96 -well filtration plates, 1.0 mL/well, 50 µm frit/well	2 Pcs/PK
004902-5	96 -well filtration plates, 1.5 mL/well, 5 µm frit/well	2 Pcs/PK
004902-20	96 -well filtration plates, 1.5 mL/well, 20 µm frit/well	2 Pcs/PK
004902-50	96 -well filtration plates, 1.5 mL/well, 50 µm frit/well	2 Pcs/PK
004903-5	96 -well filtration plates, 2.0 mL/well, 5 µm frit/well	2 Pcs/PK
004903-20	96 -well filtration plates, 2.0 mL/well, 20 µm frit/well	2 Pcs/PK
004903-50	96 -well filtration plates, 2.0 mL/well, 50 µm frit/well	2 Pcs/PK
009601-5	DVfree™ 96-well filtration plates 400 µL/well, 5 µm frit/well	2 Pcs/PK
009601-20	DVfree™ 96-well filtration plates 400 µL/well, 20 µm frit/well	2 Pcs/PK
009602-5	DVfree™ 96-well filtration plates 600 µL/well, 5 µm frit/well	2 Pcs/PK
009602-20	DVfree™ 96-well filtration plates 600 µL/well, 20 µm frit/well	2 Pcs/PK
0038401-5	DVfree™ 384-well filtration plates 150 µL/well, 5 µm frit/well	4 Pcs/PK
0038401-20	DVfree™ 384-well filtration plates 150 µL/well, 20 µm frit/well	4 Pcs/PK

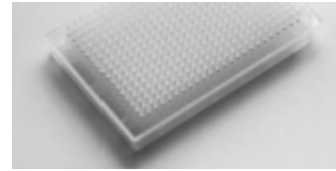
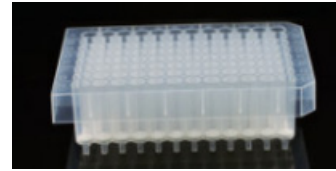
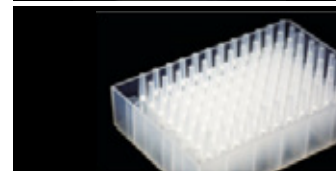
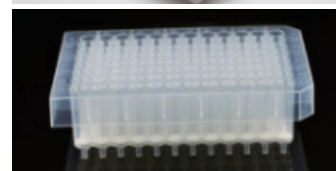
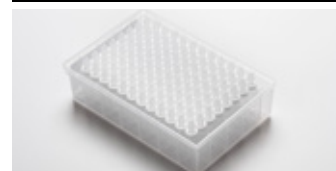
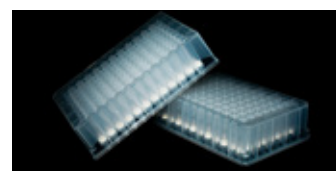

## Empty Spin Columns with Filters

Cat. #	Description	Qty.
007400	2 mL Empty Spin Columns, outer tubes, capped inner tubes, UHMW-PE frits and fixing rings	1000 Pcs /PK
007410	2 mL Empty Spin Columns, capped outer tubes, inner tubes, UHMW-PE frits and fixing rings	1000 Pcs /PK
007700	2 mL Empty Micro Spin Columns, capped outer tubes, Inner Tubes, UHMW-PE frits and fixing rings	1000 Pcs /PK
FC002	2.0 mL Empty Spin Columns, capped outer tubes, mini inner tubes, high-speed centrifuge membrane, microfiltration membrane and fixing rings	1000 Pcs /PK
FC0015	1.5 mL Empty Spin Columns, capped outer tubes, mini inner tubes, UHMW-PE frits, microfiltration membrane and fixing rings	1000 Pcs /PK
007600	15mL Empty Spin Columns, outer tubes, inner tubes, UHMW-PE frits and fixing rings	50 Pcs /PK
FC015-1	15 mL Empty Spin Columns, outer tubes, inner tubes, microfiltration membrane, frits and fixing rings	50 Pcs /PK
007500	50 mL Empty Spin Columns, outer tubes, inner tubes, UHMW-PE frits and fixing rings	10 Pcs /PK
FC050-1	50 mL Empty Spin Columns, capped outer tubes, inner tubes, microfiltration membrane, frits and fixing rings	20 Pcs /PK



## Filtration Cartridges with Plunger

Cat. #	Description	Qty.
004417-M	12 mL Filtration Cartridges, with 2 frits and 1 plunger	50 Pcs/PK
004407	20 mL Filtration Cartridges, with 2 frits and 1 plunger	50 Pcs/PK
004410-M	30 mL Filtration Cartridges, with 2 frits and 1 plunger	50 Pcs/PK
004416-M	60 mL Filtration Cartridges, with 2 frits and 1 plunger	25 Pcs/PK



## SpinFlow® Lysis-Filtration Columns

Cat. #	Description	Qty.
FS001	1.5 mL Lysis-filtration column, cappless spin column	500 Pcs/PK
FS001-1-S	1.5 mL Lysis-filtration column, cappless spin column, sterile	100 Pcs/PK
FS002	2.0 mL Lysis-filtration column, cappless spin column	500 Pcs/PK
FS002-1-SS	2.0 mL Lysis-filtration column, cappless spin column, sterile	50 Pcs/PK
FS002-2	2.0 mL Lysis-filtration column, capped spin column	100 Pcs/PK
FS002-2-S	2.0 mL Lysis-filtration column, capped spin column, sterile	100 Pcs/PK





## II. Accessories of Spin Column

### Empty Spin Columns & Collection Tubes

#### Ordering Information

Cat. #	Description	Qty.
SC-GT-UI-AJ-2	2 mL stepped spin columns with lid	1000 PCS/PK
SC-002-UI-AJ-2	2 mL capless spin columns	1000 Pcs/PK
SC-002-I-RYN-1	2 mL spin column with lid	1000 Pcs/PK
SC-0015-CO-2	1.5 mL collection tube with lid	500 Pcs/PK
SC-002-O-RY-1	2 mL capless collection tube	1000 Pcs/PK
SC-002-CO-AJ-3	2 mL collection tube with lid	1000 Pcs/PK
SC-0015-CO-AJ-2	1.5 mL collection tube with lid	50 Pcs/PK
SC-002-O-RY-50	2 mL capless collection tube	50 Pcs/PK
SC-002-CO-AJ-5	2 mL collection tube with lid	50 Pcs/PK



### Fix Rings

Fix rings are available in circles, plum, mercedes

Shape	Color
O Ring	Clear White, Yellow, Green, Blue, Purple
Plum Ring	Clear White, Yellow, Green, Blue, Purple
Mercedes Ring	Clear White, Yellow, Green, Blue, Purple



### Silica Membrane

biocomma® Silica membrane is a key component in spin columnbased nucleic acid purification technology. Under low pH and chaotropic conditions, nucleic acids specifically bind to silica membrane while polysaccharides and proteins pass through. Impurities are further removed by washing. Finally, under low-salt conditions, nucleic acids are desorbed and eluted from the membrane.

#### Features

- High quality with high yield and good reproducibility
- Suitable for spin columns or plates

#### Ordering Information

Cat. #	Description	Qty.
Y-SM-BC-1	Silica Membrane, 210*297 mm/Sheet	100 Sheet/PK
Custom		



## PE Porous Sheet

biocomma® Sintered technology of porous UHMW-PE material, offer basic components for life sciences, including nucleic acid extraction.

### Size

- 180\*180\*3.0 mm
- 300\*300\*1.5 mm
- 300\*300\*3.0 mm
- 500\*300\*3.0 mm
- 400\*300\*3.0 mm



### Ordering Information

Cat. #	Description	Qty.
F15E-300-30	300*300*1.5 mm PE porous sheet for nucleic acid extraction	10 Pcs/PK
Contact Us for different dimension request		

## Support Filter

biocomma® Support filter is made of special material, shows almost no binding to nucleic acids. It has a minimal thickness of 0.3 mm, making it an ideal component for nucleic acid purification.



### Ordering Information

Cat. #	Description	Qty.
DNAF051-03-50	2 mL Spin Columns	1000 Pcs/PK
DNAF073-03-50	2 mL Spin Columns	1000 Pcs/PK
DNAF110-03-50	15 mL Spin Columns	1000 Pcs/PK
DNAF240-03-50	50 mL Spin Columns	1000 Pcs/PK
Custom		

## OEM/ODM Service

Mold Design & Injection	Color	Membrane	Package
		<p>Thickness Material Layers</p>	<p>Pre-Assembled Tubes Individual Package Quantity/Pack</p>

# III. Validation Data

## 1. Yield and Purity of Spin Columns

Sample	Column	Conc., ng/ $\mu$ L	m, $\mu$ g	A260/A280	A260/A230
Customer A Buffer	NP30-A	93	9.3	1.8	2.0
		95	9.5	1.9	2.1
		90	9.0	1.8	2.0
Customer A Buffer	Qiagen Miniprep column	83	8.3	1.8	2.0
		88	8.8	1.8	2.1
		90	9.0	1.8	2.0
QIAprep Spin Miniprep Kit Qiagen, Cat. No 27104	NP30-A	100	10.0	1.8	2.0
		106	10.6	1.9	2.0
		104	10.4	1.9	2.1
QIAprep Spin Miniprep Kit Qiagen, Cat. No 27104	Qiagen Miniprep column	102	10.2	1.9	2.0
		101	10.1	1.8	2.0
		102	10.2	1.9	2.0

Results: The performance of NP30-A is equivalent to Qiagen spin columns with both customer and Qiagen buffer.

## 2. Stability of Spin Columns

Sample	Kit	Conc., ng/ $\mu$ L	m, $\mu$ g	A260/A280	A260/A230
NP30-A: 1 year of storage	Customer A Kit	141	14.1	1.9	2.0
		147	14.7	1.8	2.1
		151	15.1	1.9	2.2
NP30-A: New lot.	Customer A Kit	142	14.2	1.8	2.2
		159	15.9	1.8	1.8
		149	14.9	1.8	2.3
NP30-A: 1 year of storage	QIAprep Spin Miniprep Kit Qiagen, Cat. No 27104	168	16.8	1.8	2.1
		178	17.8	1.9	2.1
		160	16.0	1.8	2.0
NP30-A: New lot.	QIAprep Spin Miniprep Kit Qiagen, Cat. No 27104	162	16.2	1.8	2.0
		169	16.9	1.8	2.1
		169	16.9	1.9	2.0

Results: NP30-A show good performance after one year storage.

## 3. Purity Testing of Silica Membrane

Membrane	Extractant	m/z	Ion	Compound	Source
Biocomma Silica Membrane	Pure Water	304	M+Na+	oleamide	Slip agent in polyethylene films
		97	HSO <sub>4</sub> <sup>-</sup>		
	Methanol	360	M+Na+	erucamide	Slip agent in polyethylene films
		304	M+Na+	oleamide	Slip agent in polyethylene films
Filters from Well-known brand	Pure Water	97	HSO <sub>4</sub> <sup>-</sup>		
			H <sub>2</sub> PO <sub>4</sub> <sup>-</sup>		
	Methanol	360	M+Na+	erucamide	Slip agent in polyethylene films
		425	M+Na+	Unidentified contaminant	
		701	M+Na+		from water and solvent filters

Remarks:

- The table only records ions that match the "ESI Common Background Ions" reference table.
- The results have deducted the ions present in the blank, but if a particular m/z ion significantly exceeds the blank, it is recorded.

Conclusion:

Proceed ultrasonic extraction in both water and methanol, mass spectrometry results showed the presence of precipitates in both Biocomma membrane and well-known brand filter. Compound identification was carried out through high-resolution mass spectrometry by full scanning and matching with the "ESI Common Background Ions" reference table. The primary precipitates were HSO<sub>4</sub><sup>-</sup>, H<sub>2</sub>PO<sub>4</sub><sup>-</sup>, and Na<sup>+</sup>, and these presence is attributed to the material being glass fiber in the membranes. No other substances were found to precipitate from either of the two membranes, confirming their purity.



## IV. Other Accessories

### Magnetic Beads

#### Features

- Wide range of applicable samples
- High magnetic content, fast magnetic response, easy to isolate
- Good monodispersity
- Uniform particle size, small variance between batches, good repeatability



#### Ordering Information

Cat. #	Description	Qty.
MSI500-0501-200	Particle size 500 nm, concentration 50 mg/mL, binding capacity 10.5 µg/mg	200 mL/Bottle
MSI500-0511-200	Particle size 500 nm, concentration 50 mg/mL, binding capacity 2.5 µg/mg	200 mL/Bottle
MSI100-0507-200	Particle size 100 nm, concentration 50 mg/mL, binding capacity 12.5 µg/mg	200 mL/Bottle
MSI100-0517-200	Particle size 100 nm, concentration 50 mg/mL, binding capacity 2.0 µg/mg	200 mL/Bottle

Note: Please contact us for more specifications.

### Tip Combs

Tip Combs are made of medical grade high-purity polypropylene (PP). Both 8 and 96 Tip Combs are fit 96 square deep well plates.

#### Features

- Low binding affinity for biomolecules
- Protect the magnetic rods from reagents to extend lifespan
- Adapt to magnetic particle processing of automated nucleic acid extraction systems
- Tolerant to autoclave at 121 ° C for 20 min

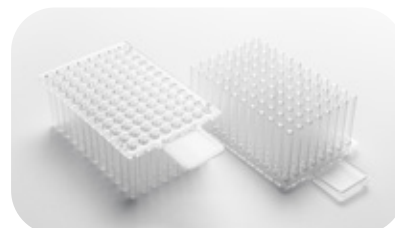

#### Ordering Information

Cat. #	Description	Qty.
8WMS	8-Strip Tip Combs	2 Pcs/PK
96WMS-CH-N-1	96 Tip Combs	2 Pcs/PK
96WP-S022-BN	96-Well Collection Plate, Square Well, 2.2 mL, U-bottom	24 Pcs/Box
96WP-S022V-N	96-Well Collection Plate, Square Well, 2.2 mL, V-bottom	24 Pcs/Box
96WP-S005V	96-Well Collection Plate, Square Well, 0.5mL, V-bottom	10 Pcs/Box

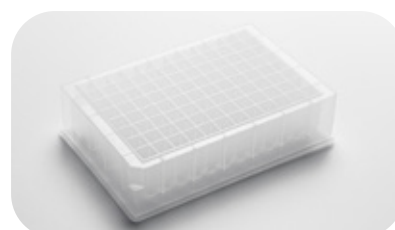

### Reagent Bottles

#### Features

- HDPE material, white
- Sterile and DNase and RNase-free, pyrogen-free package are available
- 4 mL, 8 mL, 15 mL, 30 mL, 60 mL, 125 mL, 250 mL, 500 mL, 1000 mL

Note: Please contact us for ordering information



## Proteinase K

The broad-spectrum serine protease with a relative molecular weight of approximately 29.3 kDa cleaves the carboxy-terminal peptide bonds of aliphatic and aromatic amino acids. Proteinase K is widely applied to enzymatic glycosylated hemoglobin reagents and glycosylated albumin reagents research, also a key reagent for nucleic acid extraction which enzymatically hydrolyze histones bound to nucleic acids to free DNA for subsequent purification.



### Ordering Information

Cat. #	Description	Qty.
PK01	Proteinase K powder	1 g/Bottle
PK03	Proteinase K powder	100 g/Bottle
PK04	Proteinase K powder	50 g/Bottle

## Grinding Tubes

Reinforced tubes are designed for homogenization, tissue Grinding and Cell Lysis, designed for those who wish to fill their own Lysing Matrix Tubes.



### Ordering Information

Cat. #	Description	Qty.
SC-002-MDN	Grinding tube with snap cap, 2 mL	500 Pcs/PK
33121	Grinding tube with screw cap, 2 mL	500 Pcs/PK

## Cryogenic Vials

### Features

- O-ring seal cap prevents liquid leakage
- DNase and RNase-free, pyrogen-free
- Various specifications and cap colors are available
- Sterile Package, 500 pcs/pk, 10 pks/Carton

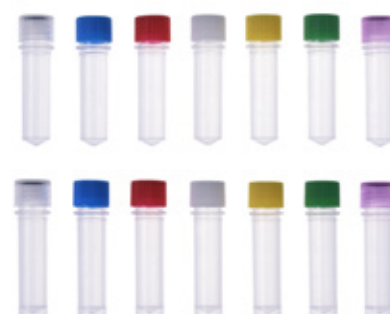

### Ordering Information

Cat. #	Description (Temperature -80°C ~121°C)	Cat. #	Description (Temperature -196 °C ~121 °C)
31009	0.5 mL Cryogenic Vials, brown, skirted	30009	0.5 mL Cryogenic Vials, brown, skirted
31019	1.5 mL Cryogenic Vials, brown, skirted	30019	1.5 mL Cryogenic Vials, brown, skirted
31029	2.0 mL Cryogenic Vials, brown, skirted	30029	2.0 mL Cryogenic Vials, brown, skirted
31001	0.5 mL Cryogenic Vials, clear, skirted	30001	0.5 mL Cryogenic Vials, clear, skirted
31011	1.5 mL Cryogenic Vials, clear, skirted	30011	1.5 mL Cryogenic Vials, clear, skirted
31021	2.0 mL Cryogenic Vials, clear, skirted	30021	2.0 mL Cryogenic Vials, clear, skirted
31109	0.5 mL Cryogenic Vials, brown, conical	30109	0.5 mL Cryogenic Vials, brown, conical
31119	1.5 mL Cryogenic Vials, brown, conical	30119	1.5 mL Cryogenic Vials, brown, conical
31129	2.0 mL Cryogenic Vials, brown, conical	30129	2.0 mL Cryogenic Vials, brown, conical
31101	0.5 mL Cryogenic Vials, clear, conical	30101	0.5 mL Cryogenic Vials, clear, conical
31111	1.5 mL Cryogenic Vials, clear, conical	30111	1.5 mL Cryogenic Vials, clear, conical
31121	2.0 mL Cryogenic Vials, clear, conical	30121	2.0 mL Cryogenic Vials, clear, conical

Note: Please contact us for different cap color.



Embed™  
Oligo Synthesis Solution

02



## Embed™ Technology

Developed since 2014, Biocomma Embed™ technology is an innovative solution for efficient, expedite and economical oligonucleotide synthesis.

Our Embed™ seamlessly blends PE powder and CPG powder, before placing them into a mold where they are heated to a high temperature, reaching a molten state. During this process, the PE and CPG materials sinter together, forming a cylinder with a sponge-like porous structure that allows air to permeate. Notably, the CPG is evenly distributed throughout, resulting in what we term a CPG frit.

By adjusting the size of the PE particles, we can precisely control the pore size of the frits. This allows us to regulate the flow rate, serving the purpose of achieving controlled and tailored flow properties.

### Advantages of our controlled flow CPG Frits:

- **Increasing Coupling Efficiency**  
Capable of yielding more full-length oligos and increase synthesis accuracy. The purity is improved more than 20%.
- **Reduced Synthesis Cost**  
Cost effective by reducing the amount of reagents, resulting in savings more than 40% in time and resources.
- **Quality Control**  
A stable flow rate ensures efficient and consistent production of DNA/RNA oligos.
- **Compatibility**  
Compatible with all types of oligo synthesizers that utilize synthesis columns, 96/384 well synthesis plates.

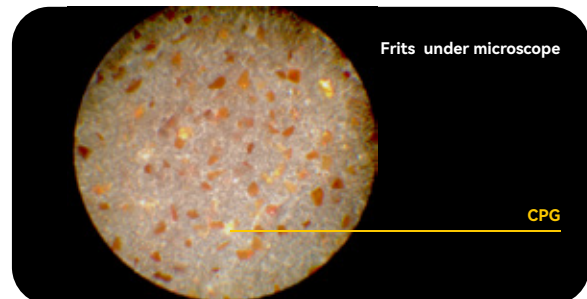
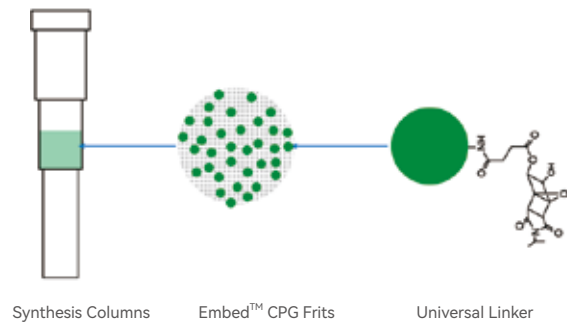

# I. Embed™ CPG Frits Synthesis Columns

## Ordering Information

MerMade 192, Dr. Oligo 48, Dr. Oligo 192 and Oligomaker 192

Cat. #	Synthesis Scale	CPG Pore Size	Qty.
AS0002	2 nmol	1000 Å	4000 Pcs/PK
AS0005	5 nmol	1000 Å	4000 Pcs/PK
DS0010	10 nmol	1000 Å	4000 Pcs/PK
DS0025	25 nmol	1000 Å	4000 Pcs/PK
DS0050	50 nmol	1000 Å	4000 Pcs/PK
DS0100	100 nmol	1000 Å	4000 Pcs/PK
DS0200	200 nmol	1000 Å	4000 Pcs/PK
DS0500	500 nmol	500 Å	4000 Pcs/PK
DS0500-1	500 nmol	1000 Å	4000 Pcs/PK
DS0500-2	500 nmol	2000 Å	4000 Pcs/PK
DS1000-1	1000 nmol	500 Å	4000 Pcs/PK
DS1000-G	1000 nmol	1000 Å	4000 Pcs/PK
DS1000-2	1000 nmol	2000 Å	4000 Pcs/PK
DS2000	2000 nmol	500 Å	4000 Pcs/PK
DS3000	3000 nmol	500 Å	4000 Pcs/PK



### ABI 3900

Cat. #	Synthesis Scale	CPG Pore Size	Qty.
DS0050-3900	50 nmol	1000 Å	500 Pcs/PK
DS0100-3900	100 nmol	1000 Å	500 Pcs/PK
DS0500-3900	500 nmol	1000 Å	500 Pcs/PK
DS1000-3900	1000 nmol	1000 Å	500 Pcs/PK



### MerMade, Oligomaker 192

Cat. #	Synthesis Scale	CPG Pore Size	Qty.
MS0200	200 nmol	1000 Å	500 Pcs/PK
MS0500	500 nmol	1000 Å	500 Pcs/PK
MS0800	800 nmol	1000 Å	500 Pcs/PK
MS0500-2	500 nmol	2000 Å	500 Pcs/PK



### ABI 394 and K&A

Cat. #	Synthesis Scale	CPG Pore Size	Qty.
DS0050-394	50 nmol	1000 Å	500 Pcs/PK
DS0500-394	500 nmol	1000 Å	500 Pcs/PK
DS01000-394	1000 nmol	1000 Å	500 Pcs/PK



## II. Traditional Oligo Synthesis Columns

### Ordering Information

#### ABI 3900

Cat. #	Synthesis Scale	CPG Pore Size	Qty.
DSI30100	100nmol	1000Å	4000 Pcs/PK
DSI30200	200nmol	1000Å	4000 Pcs/PK
DSI30500	500nmol	1000Å	4000 Pcs/PK
DSI31000	1000nmol	1000Å	4000 Pcs/PK
DSI32000	2000nmol	500Å	4000 Pcs/PK
DSI33000	3000nmol	500Å	4000 Pcs/PK
DSI30500-2	500nmol	2000Å	4000 Pcs/PK
DSI31000-2	1000nmol	2000Å	4000 Pcs/PK



#### MerMade

Cat. #	Synthesis Scale	CPG Pore Size	Qty.
MSI30100	100 nmol	1000 Å	500 Pcs/PK
MSI30200	200 nmol	1000 Å	500 Pcs/PK
MSI30500	500 nmol	1000 Å	500 Pcs/PK
MSI31000	1000 nmol	1000 Å	500 Pcs/PK
MSI32000	2000 nmol	500 Å	500 Pcs/PK
DSI10000-3	10 µmol	1000 Å	100 Pcs/PK
DSI15000-6	15 µmol	1000 Å	100 Pcs/PK
DSI30000-12	30 µmol	1000 Å	100 Pcs/PK
DSI50000-20	50 µmol	1000 Å	100 Pcs/PK



#### ABI 394 and K&A

Cat. #	Synthesis Scale	CPG Pore Size	Qty.
DS394-0200	200 nmol	2000 Å	50 Pcs/PK
DS394-0200-1	200 nmol	1000 Å	50 Pcs/PK
DS394-0500-1	500 nmol	1000 Å	50 Pcs/PK



#### Expedite 8909

Cat. #	Synthesis Scale	CPG Pore Size	Qty.
DS8909-1000	1000 nmol	1000 Å	50 Pcs/PK





# III. Synthesis Plates

## 384 Well Synthesis Plates

### Features

- Selection of higher-quality raw materials (CPG) involves rigorous testing and performance validation for each batch before production.
- The volume of CPG frit has been reduced significantly from 6.28 to 0.78  $\mu\text{L}$ .
- Optimization of the structural design of the synthesis plate includes the height of the carrier assembly to the outlet. Based on principles of fluid mechanics, the optimal value of 8 mm was selected.
- Customization of a 384-plate gas resistance instrument, referencing the principles of gas flow in synthesizers, is intended to facilitate customer on-machine adjustments.

### Ordering Information

Cat. #	Synthesis Scale	CPG Pore Size	Qty.
DS384-001-S	1 nmol	1000 Å	12 Pcs/PK
DS384-003-S	3 nmol	1000 Å	12 Pcs/PK
DS384-005-S	5 nmol	1000 Å	12 Pcs/PK

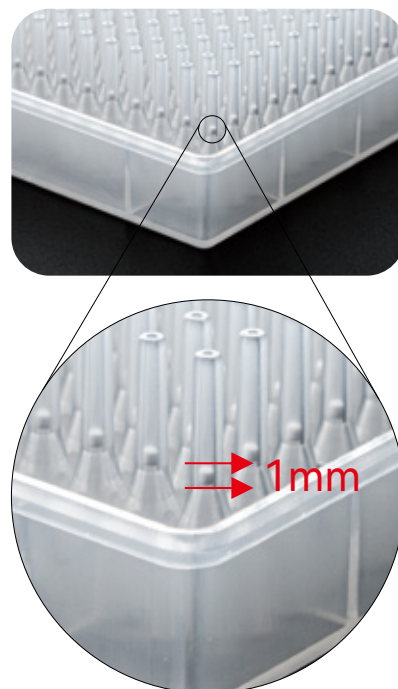

## 384-Well Synthesis Plates

Embed™ 384-Well Synthesis Plates are compatible with mainstream of commercial synthesizers, such as Dr. Oligo 768, OligoMaker 1536 and YB768/1536.

### Ordering Information

Cat. #	Synthesis Scale	CPG Pore Size	Qty.
DS384-003	3 nmol	1000 Å	12 Pcs/PK
DS384-003-2	3 nmol	2000 Å	12 Pcs/PK
DS384-005	5 nmol	1000 Å	12 Pcs/PK
DS384-010	10 nmol	1000 Å	12 Pcs/PK
DS384-010-2	10 nmol	2000 Å	12 Pcs/PK
DS384-025	25 nmol	1000 Å	12 Pcs/PK
DS384-025-2	25 nmol	2000 Å	12 Pcs/PK
DS384-030	30 nmol	1000 Å	12 Pcs/PK
DS384-050	50 nmol	1000 Å	12 Pcs/PK
DS384-100	100 nmol	1000 Å	12 Pcs/PK
DS384-200	200 nmol	1000 Å	12 Pcs/PK



## 96-Well Synthesis Plates

### Ordering Information

#### Dr. Oligo 192

Cat. #	Synthesis Scale	CPG Pore Size	Qty.
DS96-0005	5 nmol	1000 Å	7 Pcs/PK
DS96-0010	10 nmol	1000 Å	7 Pcs/PK
DS96-0025	25 nmol	1000 Å	7 Pcs/PK
DS96-0050	50 nmol	1000 Å	7 Pcs/PK
DS96-0100	100 nmol	1000 Å	7 Pcs/PK
DS96-0200	200 nmol	1000 Å	7 Pcs/PK
DS96-0500	500 nmol	1000 Å	7 Pcs/PK
DS96-0500-1	500 nmol	500 Å	7 Pcs/PK
DS96-1000-1	1000 nmol	500 Å	7 Pcs/PK
DS96-1000-G	1000 nmol	1000 Å	7 Pcs/PK
DS96-1000-2	1000 nmol	2000 Å	7 Pcs/PK
DS96-2000	2000 nmol	500 Å	7 Pcs/PK
DS96-3000	3000 nmol	500 Å	7 Pcs/PK

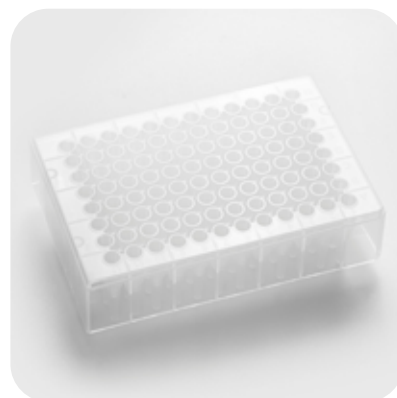

#### MerMade 192

Cat. #	Synthesis Scale	CPG Pore Size	Qty.
MS96-0002	2 nmol	1000 Å	7 Pcs/PK
MS96-0005	5 nmol	1000 Å	7 Pcs/PK
MS96-0010	10 nmol	1000 Å	7 Pcs/PK
MS96-0025	25 nmol	1000 Å	7 Pcs/PK
MS96-0050	50 nmol	1000 Å	7 Pcs/PK
MS96-0100	100 nmol	1000 Å	7 Pcs/PK
MS96-0200	200 nmol	1000 Å	7 Pcs/PK
MS96-0500	500 nmol	500 Å	7 Pcs/PK
MS96-1000	1000 nmol	1000 Å	7 Pcs/PK
MS96-1000-1	1000 nmol	500 Å	7 Pcs/PK



## IV. Desalting Purification Cartridges & Plates

### RPC Cartridges & Plates

Through specific adsorption with DMT group, the purpose of removing invalid oligonucleotide fragments such as N-1 is achieved.

#### Ordering Information

Cat. #	Description	Specification	Qty.
RPC150	RPC Purification Cartridges	50 mg/1 mL	100 Pcs/PK
RPC3100-1	RPC Purification Cartridges	100 mg/3 mL	50 Pcs/PK
RPC3300	RPC Purification Cartridges	300 mg/3 mL	50 Pcs/PK
RPC61000	RPC Purification Cartridges	1 g/6 mL	30 Pcs/PK
RPC96-50	RPC Desalting Purification Plate	50 mg/1.5 mL	4 Pcs/PK
RPC96-100	RPC Desalting Purification Plate	100 mg/1.5 mL	4 Pcs/PK
RPC96-150	RPC Desalting Purification Plate	150 mg/1.5 mL	4 Pcs/PK

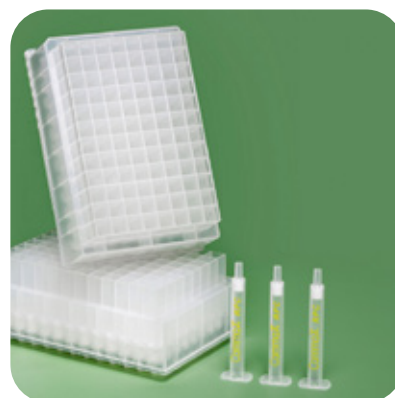

### C18 Cartridges & Plates

The oligo fragments are adsorbed through the hydrophobic interaction of 18 alkyl groups, making it suitable for oligos with 40 mer or shorter lengths.

#### Ordering Information

Cat. #	Description	Qty.
DC18150	C18 Desalting Purification Cartridge, 50 mg/1 mL	100 Pcs/Box
DC186500	C18 Desalting Purification Cartridge, 500 mg/6 mL	30 Pcs/Box
DC189650	C18 Desalting Purification Plate, 50mg/1.5mL/96well	4 Pcs/Box
C1896-080	C18 Desalting Purification Plate, 80mg/2mL/96well	4 Pcs/Box



### G25 Desalting Purification Cartridges

Based on the principle of molecular sieves, sephadex is used as the medium to separate substances by different molecular weights.

#### Ordering Information

Cat. #	Description	Qty.
DG25003	G-25 Desalting Purification Cartridges, 0.8mL/3mL	50 Pcs/PK
DG25003-1	G-25 Desalting Purification Cartridges, 1.5mL/3mL	50 Pcs/PK
DG25006	G-25 Desalting Purification Cartridges, 2mL/6mL	40 Pcs/PK
DG25012	G-25 Desalting Purification Cartridges, 4mL/12mL	20 Pcs/PK



# V. Empty Columns & Plates with Frits

## Ordering Information

### Dr. Oligo

Cat. #	Description	Qty.
DU00-Y	Empty Synthesis Columns, yellow	500 Pcs/PK
DU00-R	Empty Synthesis Columns, red	500 Pcs/PK
DU00-B	Empty Synthesis Columns, blue	500 Pcs/PK
DU00-G	Empty Synthesis Columns, green	500 Pcs/PK
M12-W	Empty Synthesis Columns, clear, for Dr. Oligo 48	500 Pcs/PK



### ABI 3900

Cat. #	Description	Qty.
D3900-W	Empty Synthesis Columns, white	1000 Pcs/PK
D3900-T	Empty Synthesis Columns, blue	1000 Pcs/PK
D3900-G	Empty Synthesis Columns, yellow	1000 Pcs/PK
D3900-C	Empty Synthesis Columns, red	1000 Pcs/PK
D3900-A	Empty Synthesis Columns, green	1000 Pcs/PK
D3900-P	Empty Synthesis Columns, purple	1000 Pcs/PK

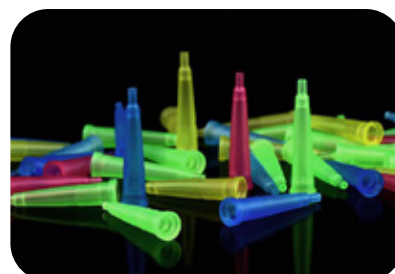

### MerMade

Cat. #	Description	Qty.
M00-W	Empty Synthesis Columns, clear	500 Pcs/PK
M00-R	Empty Synthesis Columns, red	500 Pcs/PK
M00-Y	Empty Synthesis Columns, yellow	500 Pcs/PK
M00-G	Empty Synthesis Columns, green	500 Pcs/PK
M00-B	Empty Synthesis Columns, blue	500 Pcs/PK
M13-W	Empty Synthesis Columns, clear, for 1umol-3umol	500 Pcs/PK



### ABI 394 & K&A

Cat. #	Description	Qty.
DSI394-W	Empty Synthesis Columns, length 22.7±0.5mm	100 Pcs/PK
DSI394-M	Empty Synthesis Columns, length 34.5±0.5mm	100 Pcs/PK
DSI394-L	Empty Synthesis Columns, length 42.9±0.5mm	100 Pcs/PK



### Expedite 8909

Cat. #	Description	Qty.
DSC1000	Empty Synthesis Columns, with two frits, unassembled	100 Pcs/PK





## Empty Rimless Solid Phase Synthesis Columns

biocomma® empty rimless solid phase synthesis columns are designed for automation & high-throughput applications, these empty rimless columns come with five sizes (1 mL, 3 mL, 6 mL, 12 mL and 20 mL). Their applications depend on the sorbents and frits you choose, e.g. solid-phase extraction (SPE), solid-phase synthesis. Custom options are available, of course.

### Ordering Information

Cat. #	Description	Qty.
RSSC-1	1 mL Empty Rimless Solid Phase Synthesis Columns, with Frits	100 Pcs/PK
RSSC-3	3 mL Empty Rimless Solid Phase Synthesis Columns, with Frits	100 Pcs/PK
RSSC-6	6 mL Empty Rimless Solid Phase Synthesis Columns, with Frits	100 Pcs/PK
RSSC-12	12 mL Empty Rimless Solid Phase Synthesis Columns, with Frits	100 Pcs/PK



## Dvfree™ Empty Multi-Well Plates

Reserachers are able to pack their own CPG in the plates for oligonucleotide synthesis.

### Ordering Information

Cat. #	Description	Qty.
0038401-05	Dvfree™ 384-Well Filtration Plates, 150 µL/Well, 5 µm frit	4 Pcs/PK
0038401-20	Dvfree™ 384-Well Filtration Plates, 150 µL/Well, 20 µm frit	4 Pcs/PK
009601-5	Dvfree™ 96-Well Filtration Plates, 400 µL/Well, 5 µm frit	4 Pcs/PK
009601-20	Dvfree™ 96-Well Filtration Plates, 400 µL/Well, 20 µm frit	4 Pcs/PK
009602-5	Dvfree™ 96-Well Filtration Plates, 600 µL/Well, 5 µm frit	4 Pcs/PK
009602-20	Dvfree™ 96-Well Filtration Plates, 600 µL/Well, 20 µm frit	4 Pcs/PK

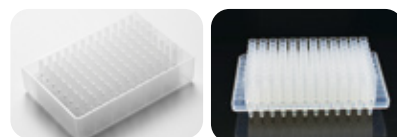
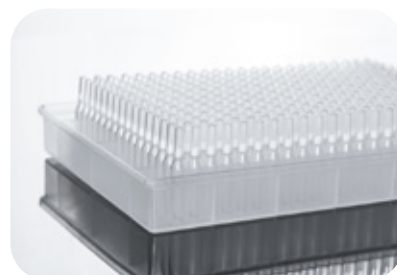

## Frits for Oligo Synthesis Columns

The UHMW-PE frits prevent the expensive CPG particles from leaking.

### Ordering Information

Cat. #	Diameter (mm)	Thickness (mm)	Pore Size (µm)	Qty.
DSF025-25-20	2.5	2.5	20	1000 Pcs/PK
DSF041-25-80	4.1	2.5	80	1000 Pcs/PK
DSF090-25-20	9.0	2.5	20	1000 Pcs/PK
DSF090-25-80	9.0	2.5	80	1000 Pcs/PK
DSF130-25-20	13.0	2.5	20	1000 Pcs/PK
DSF130-25-80	13.0	2.5	80	1000 Pcs/PK
Custom frits				

### Frits for PolyGen Synthesizer

Cat. #	Diameter (mm)	Thickness (mm)	Pore Size (µm)	Qty.
BF030-12-20	3.0	1.2	20	1000 Pcs/PK
Custom frits				



## VI. Family Products

### Solvent Filter

Application: filter impurities in solutions, avoid pipeline blockage and remove larger particles

#### Ordering Information

Cat. #	Description	Qty.
IFA064-16-1	Solvent Filter, OD tube 1/16", 10 um porosity	100 Pcs/PK
IFA064-16-20	Solvent Filter, OD tube 1/16", 20 um porosity	100 Pcs/PK
IFA064-16-50	Solvent Filter, OD tube 1/16", 50 um porosity	100 Pcs/PK
IFA065-8-1	Solvent Filter, OD tube 1/8", 5 um porosity	100 Pcs/PK
IFA065-8-20	Solvent Filter, OD tube 1/8", 20 um porosity	100 Pcs/PK
IFA065-8-50	Solvent Filter, OD tube 1/8", 50 um porosity	100 Pcs/PK
IFA110-4-1	Solvent Filter, OD tube 1/4", 5 um porosity	100 Pcs/PK
IFA110-4-20	Solvent Filter, OD tube 1/4", 20 um porosity	100 Pcs/PK
IFA110-4-50	Solvent Filter, OD tube 1/4", 50 um porosity	100 Pcs/PK
IFA096-150-100	Solvent Filter, OD tube of 3/16", 100 um porosity	100 Pcs/PK

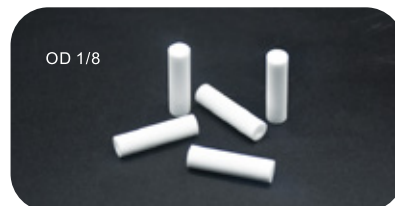
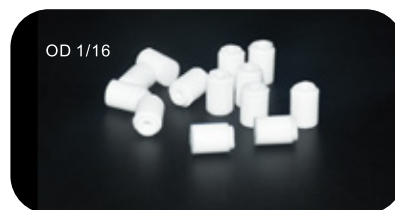

### Molecular Sieve

Application: keep your DNA RNA oligo synthesis or peptide synthesis reagents stable by removing unwanted moisture in water sensitive reagents.

#### Ordering Information

Cat. #	Description	Qty.
MT-10	Molecular Sieve, 10 g/Pc	25 Pcs/PK
MT-20	Molecular Sieve, 20 g/Pc	25 Pcs/PK



### Phosphoramidites

Amidites for Natural DNA Synthesis with Standard Base Protection

#### Ordering Information

Cat. #	Description	Qty.
BC1-004	DMT-dA(Bz)-CE Phosphoramidite 10 g/BTL	32 BTL/Ctn.
BC3-007	DMT-dC(Ac)-CE Phosphoramidite 10 g/BTL	32 BTL/Ctn.
BC3-003	DMT-dC(Bz)-CE Phosphoramidite 10 g/BTL	32 BTL/Ctn.
BC2-006	DMT-dG(dmfm)-CE Phosphoramidite 10 g/BTL	32 BTL/Ctn.
BC2-004	DMT-dG(iBu)-CE Phosphoramidite 10 g/BTL	32 BTL/Ctn.
BC4-002	DMT-dT-CE Phosphoramidite 10 g/BTL	32 BTL/Ctn.



## Universal CPG

### Features

- The whole industry chain of naked CPG and Linker, with mature and stable technology
- Production capacity of 10 kg each batch, the most advanced platinum reaction vessel in the industry
- Better bonding processes higher purity of primer synthesis

### Ordering Information

CPG	Cat. #	Pore Size	Qty.
Universal CPG	CPG500-BC	500Å	50g/Bottle
	CPG1000-BC	1000Å	50g/Bottle
	CPG2000-BC	2000Å	50g/Bottle
	CPG3000-BC	3000Å	50g/Bottle
Amino Icaa CPG	N-500-BC	500Å	50g/Bottle
	N-1000-BC	1000Å	50g/Bottle
Naked CPG	CPG500-N	500Å	50g/Bottle
	CPG1000-N	1000Å	50g/Bottle
	CPG2000-N	2000Å	50g/Bottle

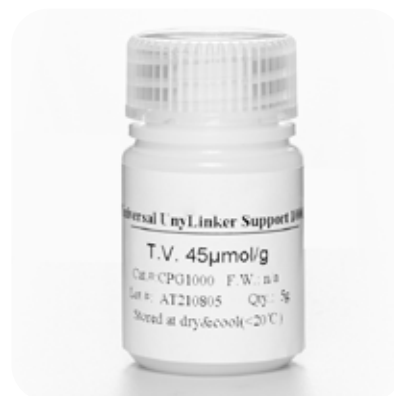

## Dyes & Quenchers

Description	
5'-Fluorescein Phosphoramidite (6-FAM)	Qusar570 CE Phosphoramidite
5'-Hexachloro-Fluorescein Phosphoramidite (HEX)	Qusar670 CE Phosphoramidite
6-Fluorescein Phosphoramidite	Cy3 MMT Phosphoramidite
6-Hexachloro-Fluorescein Phosphoramidite	Cy5 MMT Phosphoramidite
Cyanine 3 Phosphoramidite	BHQ-1-dT Phosphoramidite
Cyanine 5 Phosphoramidite	BHQ-2-dT Phosphoramidite
CAL Fluor Red 610 Phosphoramidite	3'-BHQ-1 CPG
JOE Phosphoramidite	3'-BHQ-2 CPG
VIC Phosphoramidite	3'-BHQ-3 CPG
MGB CPG, 1000Å	

## DNA/RNA Monomers & Modifiers

Description	
CPG 1000A dA (Bz)	2'-OMe-rC(N-Ac) CE Phosphoramidite
CPG 1000A dC (Bz/Ac)	2'-OMe-rG(N-iBu) CE Phosphoramidite
CPG 1000A dG (Ib/dmf)	2'-OMe-rA(N-Bz) CE Phosphoramidite
CPG 1000A dT	DMT-2'-TBDMS-A (Bz)-CE Phosphoramidite
DMT-2'-O-MOE-A (Bz)-CE Phosphoramidite	DMT-2'-O-TBDMS-C (Ac)-CE Phosphoramidite
5-Me-DMT-2'-O-MOE-C (Bz)-CE Phosphoramidite	DMT-2'-O-TBDMS-G (iBu)-CE Phosphoramidite
DMT-2'-O-MOE-G (iBu)-CE Phosphoramidite	DMT-2'-O-TBDMS-U-CE Phosphoramidite
DMT-2'-O-MOE-T-CE Phosphoramidite	3-Biotin CPG 1000
2'-OMe-rA(N-Bz) CE Phosphoramidite	Chemical Phosphorylation Reagent I
2'-OMe-Bz-rA CE Phosphoramidite	3' Amino modifier CPG



**Proteomics**

**03**



## Protein Purification Prepacked Columns

biocomma® Protein Purification Prepacked Columns, aiming at simplifying work in protein purification, are specially designed for the purification, desalting and concentration of antibodies, recombinant proteins and other biological macromolecules. The columns offer chromatography solutions with stable quality, convenient operation, and timesaving and labor-saving.



### Ion Exchange Chromatography

#### ● SP Copure FF Prepacked Columns

SP Copure FF Prepacked Columns are prepacked with SP Copure FF media. A strong cation exchanger is suitable for protein purification, screening and elution.

Cat. #	Description	Max. Flow Rate (ml/min)	Partical Diameter (µm)	Loading Value	Max. Operating Pressure (Mpa)	pH Range
P-IX0102-11	SP Copure FF Prepacked Columns 1×1mL	4	75	>120mg lysozyme	0.5	4-13 3-14
P-IX0102-51	SP Copure FF Prepacked Columns 5×1mL					
P-IX0102-15	SP Copure FF Prepacked Columns 1×5mL	20	75	>120mg lysozyme	0.5	4-13 3-14
P-IX0102-55	SP Copure FF Prepacked Columns 5×5mL					

#### ● SP Copure HP Prepacked Columns

Strong cation exchange chromatography columns are prepacked with SP Copure HP media. Relatively smaller particle size provides more efficient and high-resolution purification.

Cat. #	Description	Max. Flow Rate (ml/min)	Partical Diameter (µm)	Loading Value	Max. Operating Pressure (Mpa)	pH Range
P-IX0101-11	SP Copure HP Prepacked Columns 1×1mL	4	40	55mg ribonuclease	0.35	4-13 3-14
P-IX0101-51	SP Copure HP Prepacked Columns 5×1mL					
P-IX0101-15	SP Copure HP Prepacked Columns 1×5mL	20	40	55mg ribonuclease	0.35	4-13 3-14
P-IX0101-55	SP Copure HP Prepacked Columns 5×5mL					

#### ● NI Copure FF Prepacked Columns

The ready-to-use columns could be used for preparative purification of histidine-tagged recombinant proteins by chelate and metalion affinity chromatography.

Cat. #	Description	Max. Flow Rate (ml/min)	Partical Diameter (µm)	Loading Value	Max. Operating Pressure (Mpa)	pH Range
P-AC0101-11	NI Copure FF Prepacked Columns 1×1mL	4	90	> 40mg	0.35	3-12 2-14
P-AC0101-51	NI Copure FF Prepacked Columns 5×1mL					
P-AC0101-15	NI Copure FF Prepacked Columns 1×5mL	20	90	> 40mg	0.35	3-12 2-14
P-AC0101-55	NI Copure FF Prepacked Columns 5×5mL					

#### ● Mab Copure SE Prepacked Columns

Mab Copure SE is a kind of medium to capture monoclonal antibodies from samples, which are highly recommended for Mab purification from high-level expression feedstocks in increased media loading value.

Cat. #	Description	Max. Flow Rate (ml/min)	Partical Diameter (µm)	Loading Value	Max. Operating Pressure (Mpa)	pH Range
P-AC0301-11	Mab Copure SE Prepacked Columns 1×1mL	4	75	Dynamic 30mg IgG/mL	0.35	3-12 3-12
P-AC0301-51	Mab Copure SE Prepacked Columns 5×1mL					
P-AC0301-15	Mab Copure SE Prepacked Columns 1×5mL	20	75	Dynamic 30mg IgG/mL	0.35	3-12 3-12
P-AC0301-55	Mab Copure SE Prepacked Columns 5×5mL					

#### ● GST Copure FF Prepacked Columns

Prepacked GST Copure FF media purifies S-transferase (GST)-tagged proteins at high-resolution in one step.

Cat. #	Description	Max. Flow Rate (ml/min)	Partical Diameter (µm)	Loading Value	Max. Operating Pressure (Mpa)	pH Range
P-AC0201-11	GST Copure FF Prepacked Columns 1×1mL	4	90	> 12mg	0.5	3-12 3-12
P-AC0201-51	GST Copure FF Prepacked Columns 5×1mL					
P-AC0201-15	GST Copure FF Prepacked Columns 1×5mL	20	90	> 12mg	0.5	3-12 3-12
P-AC0201-55	GST Copure FF Prepacked Columns 5×5mL					

## GICA Optimizer

biocomma® GICA Optimizer protects antibodies, enhances colloidal stability, and extends antibody shelf life.

### Features

- Reduce matrix effects, especially matrix effects of urine sample
- Increase hydrophilicity to shorten the reaction time of antigen-antibody
- Protect antibodies, reduce shedding of labeled antibodies
- Increased accuracy of quantitative test to optimize the standard curve
- Better uniformity and between-run reproducibility



### Ordering Information

Cat. #	Description	Qty.
001000	Optimized Kit: SDS-L (20 mL), SDS-F (20g), L-90D (35g), L-30 (35g)	1 Set/Box
001011-1	SDS-L GICA Optimizer (50 mL/Bottle)	4 Bottle/Box
001012-1	SDS-F GICA Optimizer (50 g/Bottle)	4 Bottle/Box
001013-1	L-90D GICA Optimizer (50 g/Bottle)	4 Bottle/Box
001014-1	L-30 GICA Optimizer (50 g/Bottle)	4 Bottle/Box

## Prestained Protein Ladder

Biocomma® Prestained Protein Ladder is available in various colors of purple, yellow, red, orange, green and blue. The protein ladder can be transported at room temperature, and store up to 2 years at -20 °C .



### Features

- Broad range
- Precise indication
- Clear band trace
- Colorful prestained colors
- Customization
- Ready to use

### Ordering Information

Without His-tag Ladder

Cat. #	Description	Qty.
PMK01-01	Prestained Protein Ladder: 8 (Green), 17, 25, 33, 43, 55, 72(Orange), 100, 130, 180 KDa	250 µL
PMK01-05		5×250 µL
PMK02-01	Prestained Protein Ladder: 2.6, 4.2, 7, 10 (Green), 15, 20, 25, 30, 40 (Orange) KDa	250 µL
PMK02-05		5×250 µL
PMK03-01	Prestained Protein Ladder: 10, 15, 20, 25 (Green), 30, 40, 50, 72 (Orange), 100, 130, 250 KDa	250 µL
PMK03-05		5×250 µL

His-tagged Standard Ladder

Cat. #	Description	Qty.
PMK04-01	Prestained Protein Ladder: 10 (Green), 17, 25, 33, 43, 55, 70 (Orange), 95, 130, 180 KDa	250 µL
PMK04-05		5×250 µL
PMK05-01	Prestained Protein Ladder: 10, 17, 25 (Green), 34, 43, 55, 75 (Orange), 95, 130, 180 KDa	250 µL
PMK05-05		5×250 µL
PMK06-01	Prestained Protein Ladder: 15, 20, 25, 35, 50, 70 (Orange), 100, 130 KDa	250 µL
PMK06-05		5×250 µL

## Frits for Affinity Chromatography (AC) Columns

Frits, used in affinity chromatography columns, hold the medium in place and help protect the medium from running dry under buffer flow.

biocomma® frits for affinity chromatography (AC) columns are made from uniform and pure UHMW-PE and have excellent hydrophilicity through surface modification.

Optimized in pore size, flowrate control and chemical resistance, frits for AC columns are designed to desalt and purify peptides, proteins, antibodies, oligonucleotides, and mycotoxins.



### Features

- Excellent hydrophilicity through special processing
- Optimized uniform flowrate at 1-2 mL/min under gravity flow
- Quality is guaranteed with strict criteria of quality

### Ordering Information

Cat. #	Diameter (mm)	Thickness (mm)	Pore Size (µm)	Usage	Qty.
ACF058-16-50	5.8	1.6	50	1 mL Columns	1000 Pcs/PK
ACF090-16-50	9.0	1.6	50	3 mL Columns	1000 Pcs/PK
ACF091-16-50	9.1	1.6	50	3 mL Columns	1000 Pcs/PK
ACF130-16-50	13.0	1.6	50	6 mL Columns	1000 Pcs/PK
ACF158-16-50	15.8	1.6	50	12 mL Columns	1000 Pcs/PK
ACF228-16-50	22.8	1.6	50	30 mL Columns	1000 Pcs/PK
ACF266-16-50	26.6	1.6	50	60 mL Columns	1000 Pcs/PK
ACF380-16-50	38.0	1.6	50	150 mL Columns	100 Pcs/PK
ACF495-16-50	49.5	1.6	50	300 mL Columns	100 Pcs/PK
Custom frits					

## Empty Luer-Inlet AC Columns

### Features

- Medical-grade polypropylene tubes with Luer inlets and Luer outlets
- Two or three columns can be operated in series
- Frits are optimized to ensure good hydrophilicity and uniform flowrates

### Applications

- Purification of tagged proteins, recombinant proteins and antibodies
- Desalting of nucleic acids, peptides and proteins
- Detection of mycotoxins



### Ordering Information

Cat. #	Description	Qty.
004205-2	1 mL Empty Luer-Inlet AC Columns	100 Pcs/Box
004207	3 mL Empty Luer-Inlet AC Columns	100 Pcs/Box

## Empty Affinity Chromatography (AC) Columns

AC columns are designed for gravity flow applications such as purification and desalting of nucleic acids, proteins, enzymes, lectins, antibodies, and antigens. Top caps are pierceable for applying positive pressure using syringes

### Features

- Medical-grade polypropylene tubes with Luer outlets
- Frits are optimized with good hydrophilicity and a stable flow-rate

### Ordering Information

Cat. #	Description	Qty.
004201	1 mL Empty AC Columns	500 Pcs/Box
004202	3 mL Empty AC Columns	100 Pcs/Box
004202-N	3 mL Empty AC Columns, with Luer-Inlet Upper caps	100 Pcs/Box
004203	6 mL Empty AC Columns	100 Pcs/Box
004204	12 mL Empty AC Columns	100 Pcs/Box
004206	30 mL Empty AC Columns	50 Pcs/Box
004209	60 mL Empty AC Columns	25 Pcs/Box
004215	150 mL Empty AC Columns	15 Pcs/Box
004208	300 mL Empty AC Columns	10 Pcs/Box

Note: The standard upper caps of empty AC columns are red, various colors like orange, white, blue and green are available in 1 mL and 3 mL columns.

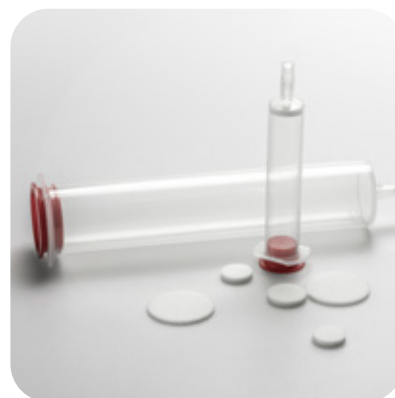

## Empty Affinity Chromatography (AC) Column Kits

The kits include empty tubes, frits, upper and bottom caps, plunger, syringe and pipe for customers to pack their own column.

### Procedures:

1. Pretreating Frits: Place the top and bottom frits into deionized water or 20% ethanol to release the air in the frit.
2. Loading Bottom Frit: Add few drops of deionized water or 20% ethanol to the column. Then, push the bottom frit to the bottom by a plunger and cap the bottom cap.
3. Adding Resin: Transfer the resin to the column. Allow the resin to settle and fill the column.
4. Loading Top Frit: Push the top frit horizontally to the end by a plunger.
5. Sealing and Storage: Fill the column with solvent without bubbles. Cap the upper cap.

### Ordering Information

Cat. #	Description	Qty.
006001	Empty AC Column Kits for 1 mL Columns	10 Sets/Box
006002	Empty AC Column Kits for 3 mL Columns	10 Sets/Box
006003	Empty AC Column Kits for 6 mL Columns	10 Sets/Box
006004	Empty AC Column Kits for 12 mL Columns	10 Sets/Box
006005	Empty AC Column Kits for 30 mL Columns	5 Sets/Box
006006	Empty AC Column Kits for 60 mL Columns	5 Sets/Box
006009-1	Empty AC Column Kits for 150 mL Columns	5 Sets/Box
006008	Empty AC Column Kits for 300 mL Columns	3 Sets/Box
006007	Empty AC Columns Kits for 1 mL Luer-Inlet Columns	10 Sets/Box

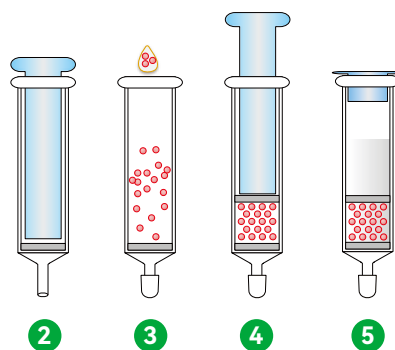



# Empty FPLC Columns

biocomma® Empty FPLC Columns are powerful tools for purification of tagged proteins, antibodies and other biomolecules. Researchers can pack columns with their own chromatographic media using different separation mechanisms (e.g., immunoaffinity, ion exchange, size exclusion, reverse phase) to perform various applications.

Each empty FPLC column includes one column tube, one sealing sleeve, one sealing plug, one top frit, one bottom frit, one top stop plug and one bottom stop plug. The columns are made of biocompatible polypropylene that does not interact with biomolecules. The top and bottom frits are manufactured from porous polypropylene. There is a snap-off end on the outlet.

Biocomma provides 1 mL and 5 mL empty FPLC columns, which can be operated with LC systems such as ÄKTA purifiers, peristaltic pumps or syringes.

### Features

- Superior biocompatibility
- Direct connection with GE ÄKTA purifiers
- Two or three columns can be operated in series

### Applications

- Purification of tagged proteins, recombinant proteins and antibodies
- Desalting of nucleic acids, peptides and proteins

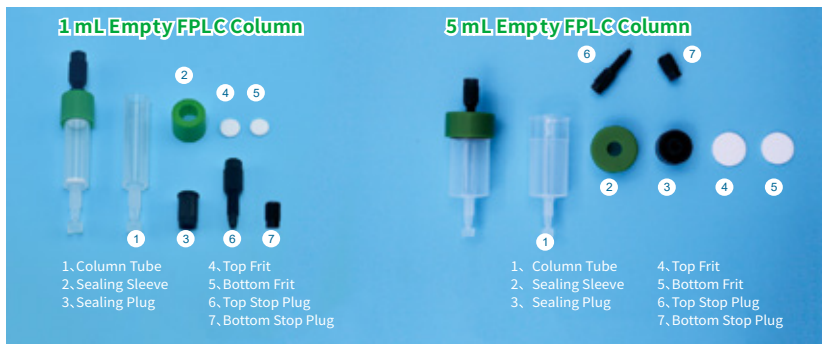
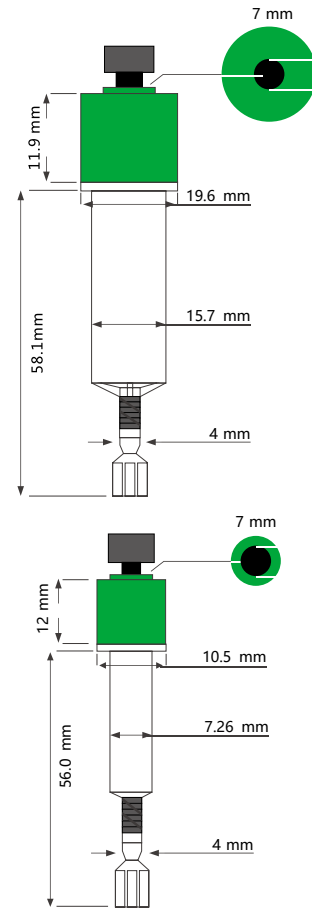

### Ordering Information

Cat. #	Description	Maximum Pressure	Qty.
MPPC001-2	1 mL Empty FPLC Columns	1 MPa	50 Sets/PK
MPPC001-2-5T	1 mL Empty FPLC Columns	(10 bar, 145 psi)	5 Sets/PK
MPPC005-2	5 mL Empty FPLC Columns	0.5 MPa	50 Sets/PK
MPPC005-2-5T	5 mL Empty FPLC Columns	(5 bar, 72.5 psi)	5 Sets/PK
MPPC001-8	1mL Empty FPLC Columns, explosion proof screw caps		50 Sets/PK
MPPC005-8	5mL Empty FPLC Columns, explosion proof screw caps		50 Sets/PK
009808-1	1 mL FPLC Column Assembly Tool		1 Set/PK
009808-5	5 mL FPLC Column Assembly Tool		1 Set/PK
009114	1 mL FPLC Plunger		1 Pc/PK
009115	5 mL FPLC Plunger		1 Pc/PK

## Empty Screw Cap Spin Columns

biocomma® Empty Screw Cap Spin Columns are designed for small volume protein purification, which can be filled with different chromatography media such as agarose, dextran, ion exchange resin, biogel and etc. The principle is centrifugation to purify protein quickly.

### Direction

Load affinity resin and other fillers into the spin column. After the filler deposit automatically, gently remove the twists off bottom and allow the excess buffer flow out. Load the sample to combine, then, centrifuge to remove unbound impurities. Finally, elute purified products.

### Features

- Columns are made of medical polypropylene with polyethylene frits, ensuring minimal protein-binding properties
- Compatible with 1.5 mL and 2.0 mL centrifuge tubes
- Capacity: 800  $\mu$ L
- Resin volume: 40–400  $\mu$ L
- O-ring screw top caps and twist-off bottom

### Ordering Information

Cat. #	Description	Qty.
FC7300-1	800 $\mu$ L Empty Screw Cap Spin Columns, Hydrophilic	50 Pcs/Box
FC7300-2	800 $\mu$ L Empty Screw Cap Spin Columns, Hydrophobic	50 Pcs/Box

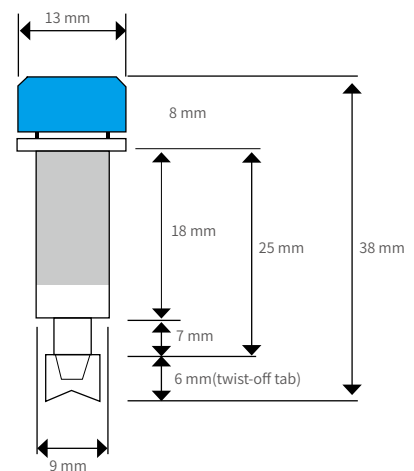

## Empty Micro-spin Chromatography Columns

biocomma® Empty Micro-spin Chromatography Columns are designed for easy and efficient small-scale protein purification. Researchers can pack a wide range of chromatography resins to purify proteins of interest using a microcentrifuge.

Researchers can pack columns with their own chromatographic media using different separation mechanisms (e.g., immunoaffinity, ion exchange, size exclusion, reverse phase) to realize various applications.



### Features

- Tubes are made of high quality medical-grade polypropylene
- Sintered UHMW-PE Frits with excellent solvent compatibility
- Suitable for 1.5 mL and 2.0 mL microcentrifuge tubes
- Volume of spin column: 800 µL
- Volume of resin: 20-500 µL

### Applications

Affinity chromatography, desalting, IP, co-IP

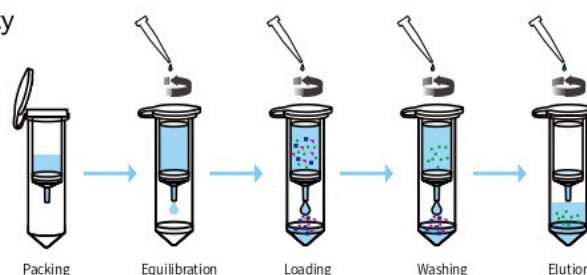

### Ordering Information

Cat. #	Description	Qty.
FC7400-1	2 mL Empty Micro-spin Chromatography Columns, including Collection Tubes (2.0 mL), Spin Columns (800 µL, with lids), Frits and Bottom Caps	100 Pcs/PK
FC7400-3	1.5 mL Empty Micro-spin Chromatography Columns, including Collection Tubes (1.5 mL), Spin Columns (800 µL, with lids), Frits and Bottom Caps	100 Pcs/PK
FC7410-1	2 mL Empty Micro-spin Chromatography Columns, including Collection Tubes (2.0 mL), Spin Columns (800 µL, without lids), Frits and Bottom Caps	100 Pcs/PK
FC7410-2	1.5 mL Empty Micro-spin Chromatography Columns, including Collection Tubes (1.5 mL), Spin Columns (800 µL, without lids), Frits and Bottom Caps	100 Pcs/PK

## Empty Spin Chromatography Columns

biocomma® Empty Spin Chromatography Columns are designed for easy and efficient large-scale protein purification.

### Features

- Tubes are made of high quality medical-grade polypropylene
- Sintered UHMW-PE Frits with excellent solvent compatibility
- Suitable for 15 mL and 50 mL centrifuge tubes
- Volume of spin column: 4 mL/22 mL

### Applications

Affinity chromatography, desalting, IP, co-IP



### Ordering Information

Cat. #	Description	Qty.
FC7600	15 mL Empty Spin Chromatography Columns, including Collection Tubes (15 mL), Spin Columns (4 mL), Frits and Bottom Caps	50 Pcs/PK
FC7500	50 mL Empty Spin Chromatography Columns, including Collection Tubes (50 mL), Spin Columns (22 mL), Frits and Bottom Caps	20 Pcs/PK

Distributed by:

**CliniSciences Group**



Bioprocess

04



# Erlenmeyer Flasks

Erlenmeyer Flasks are ideal for suspension cell culture and storage such as bacteria, fungi, animal and plant cells. biocomma® disposable flask is an economical tool comparing to traditional flasks, plates and dishes.

## Features:

- The body is made of medical polycarbonate (PC), which meets the requirements of ISO10993 USP (661).
- The advantages of PC are high transparency, strong impact resistance, oxidation resistance, and high temperature resistance up to 121 ° C.
- Clear and accurate scale on the outer wall is convenient to read the volume.
- Optional sealed cap or vent cap with a 0.22 µm PTFE membrane which is air-permeable and allows gas exchange without contamination.
- Automatically produced in self-owned GMP standard workshop with good consistency, stable supply, and cost control.
- DNase/RNase-free, pyrogen-free, and precipitation-free.
- Individual packaged and radiation sterilized, highest Sterility Assurance Level (SAL) of 10<sup>-6</sup>.
- Suitable for small-scale development, cell culture scale-up and other training stages.





Cat. #	Description	Volume (mL)	Cap	Bottom	Qty.
23101	125 mL Erlenmeyer Culture Flasks	125	Vent	Plain	24 Pcs/PK
23102	125 mL Erlenmeyer Culture Flasks	125	Seal	Plain	24 Pcs/PK
23201	250 mL Erlenmeyer Culture Flasks	250	Vent	Plain	12 Pcs/PK
23202	250 mL Erlenmeyer Culture Flasks	250	Seal	Plain	12 Pcs/PK
23301	500 mL Erlenmeyer Culture Flasks	500	Vent	Plain	12 Pcs/PK
23302	500 mL Erlenmeyer Culture Flasks	500	Seal	Plain	12 Pcs/PK
23401	1 L Erlenmeyer Culture Flasks	1000	Vent	Plain	12 Pcs/PK
23402	1 L Erlenmeyer Culture Flasks	1000	Seal	Plain	12 Pcs/PK
23105	125 mL Erlenmeyer Culture Flasks	125	Vent	Baffled	24 Pcs/PK
23106	125 mL Erlenmeyer Culture Flasks	125	Seal	Baffled	24 Pcs/PK
23205	250 mL Erlenmeyer Culture Flasks	250	Vent	Baffled	12 Pcs/PK
23206	250 mL Erlenmeyer Culture Flasks	250	Seal	Baffled	12 Pcs/PK
23305	500 mL Erlenmeyer Culture Flasks	500	Vent	Baffled	12 Pcs/PK
23306	500 mL Erlenmeyer Culture Flasks	500	Seal	Baffled	12 Pcs/PK
23405	1 L Erlenmeyer Culture Flasks	1000	Vent	Baffled	12 Pcs/PK
23406	1 L Erlenmeyer Culture Flasks	1000	Seal	Baffled	12 Pcs/PK
23501	2 L Erlenmeyer Culture Flasks	2000	Vent	Baffled	6 Pcs/PK
23502	2 L Erlenmeyer Culture Flasks	2000	Seal	Baffled	6 Pcs/PK
23601	3 L Erlenmeyer Culture Flasks	3000	Vent	Baffled	4 Pcs/PK
23602	3 L Erlenmeyer Culture Flasks	3000	Seal	Baffled	4 Pcs/PK
23701	5 L Erlenmeyer Culture Flasks	5000	Vent	Plain	4 Pcs/PK
23702	5 L Erlenmeyer Culture Flasks	5000	Seal	Plain	4 Pcs/PK

## Notes

1. The amount of medium should be well controlled. The recommended working volume of CommaClean® Erlenmeyer Flasks of 3 L and below is 30%-40% of the volume, and 50%-70% is recommended above 3 L.
2. The shaker speed required by CommaClean® Erlenmeyer Flasks is determined by working volume, shaker amplitude (orbital diameter), cell line, type of medium, baffled bottom or not, and many other factors.  
The recommended shaker speed for CommaClean® Erlenmeyer Flasks is 75 rpm-125 rpm generally.
3. Pay attention to the water level for the shaker with liquid vibration and the temperature for the shaker with gas vibration.

## Aseptic Transfer Caps for Erlenmeyer Flask

Depending on different processes or cultivation environments, the erlenmeyer flask needs to be used with different caps and tubing systems.

The multi-function and bidirectional aseptic transfer caps can be used for the bidirectional transfer of liquids. They facilitate the addition and collection of solutions through peristaltic pumps conveniently, safely, and effectively. The inverted aseptic transfer cap allows the addition of solutions through a peristaltic pump, and when it's time for harvesting, the flask is inverted to let gravity assist in collecting and storing the solution.

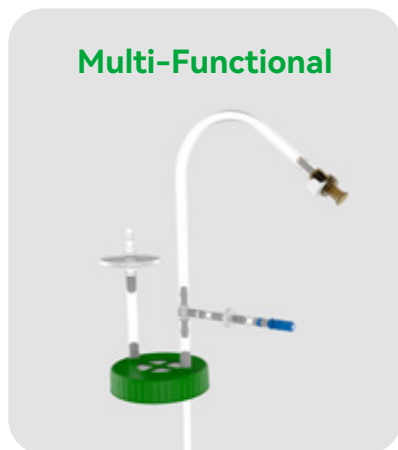

**Multi-Functional**

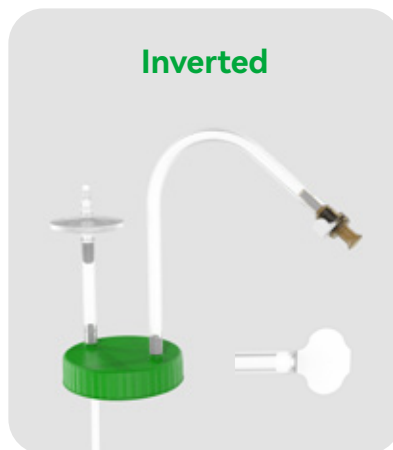

**Inverted**



**Bidirectional**



Cat. #	Description	Qty.
23901	Multi-Functional Aseptic Transfer Caps for 3 L Erlenmeyer Flask	4 Pcs/PK
23801	Multi-Functional Aseptic Transfer Caps for 5 L Erlenmeyer Flask	4 Pcs/PK
23902	Inverted Aseptic Transfer Caps for 3 L Erlenmeyer Flask	4 Pcs/PK
23802	Inverted Aseptic Transfer Caps for 5 L Erlenmeyer Flask	4 Pcs/PK
23903	Bidirectional Aseptic Transfer Caps for 3 L Erlenmeyer Flask	4 Pcs/PK
23803	Bidirectional Aseptic Transfer Caps for 5 L Erlenmeyer Flask	4 Pcs/PK

# Square Media Bottles



## Features:

- Made of light weight, and anti-crushing PET/PETG
- Highly transparent and thickened bottle body is easy to observe
- Good chemical stability is suitable for storing high-clean reagents, granular standard substances and standards
- Founded bottle body conforms to ergonomics, and easy to hold
- Unique T-shaped thread structure to ensure good sealing
- Strict leak test to ensure no leakage during air transportation
- Produced in Class 100,000 GMP standard workshop
- Gamma ray sterilization, up to 10<sup>-6</sup> Sterility Assurance Level (SAL)
- Strict quality control on raw material and products to meet biological testing standards
- Used to pack and transport liquid medium, buffer and serum
- Pyrogen free

## Applications

Square Media Bottles are suitable for storage or transportation of reagents, especially for production and storage of cell culture medium, cell serum, sterile buffer and other reagents.



All caps are universal. Also, universal for the most manufacturers in the market.



Injection, stretch and blow molding at one time to ensure good sealing.



Ergonomic founded design is easy to hold and save space.



Good consistency of products.

Cat. #	Volume (mL)	Material	Length (mm)	Width (mm)	Height (mm)	Diameter (mm)	Weight (g)	Qty.
22101	50mL	PET	40	40	82	22	18	72 Pcs/PK, 360 PK/Ctn.
22201	125mL	PET	54	54	108	28	46	25 Pcs/PK, 100 PK/Ctn.
22301	250mL	PET	59	59	146	28	54	30 Pcs/PK, 60 PK/Ctn.
22410	500mL	PET	76	76	175	28	87	24 Pcs/PK, 48 PK/Ctn.
22510	1000mL	PET	92	92	216.5	28	114	24 Pcs/PK, 48 PK/Ctn.
22601	30mL	PETG	38	38	60.5	13.6	12.6	40 Pcs/PK, 400 PK/Ctn.
22105	50mL	PETG	40	40	82	22	18	72 Pcs/PK, 360 PK/Ctn.
22705	60mL	PETG	40	40	79.2	23.8	18.3	72 Pcs/PK, 360 PK/Ctn.
22205	125mL	PETG	54	54	108	28	45	25 Pcs/PK, 100 PK/Ctn.
22305	250mL	PETG	59	59	146	28	54	30 Pcs/PK, 60 PK/Ctn.
22411	500mL	PETG	77	77	175	28	102	24 Pcs/PK, 48 PK/Ctn.
22511	1000mL	PETG	92	92	216	28	152	24 Pcs/PK, 48 PK/Ctn.

# CommaSep® Dry Blend Buffered Packs

CommaSep® Dry Blend Buffered Packs have stable quality and good batch-to-batch variation to meet the large quantities needs of laboratories.

## Ordering Information

Cat. #	Description	Qty
PBS-50	PBS: 10mM Phosphate, 137 mM NaCl, 2.7 mM KCl, pH 7.4	50 Pcs/PK
PBST-50	PBS buffer with Tween-20: 10 Mm Phosphate, 137 mM NaCl, 2.7mM KCl 0.05% Tween-20, pH 7.4	50 Pcs/PK
DPBS-N50	DPBS Buffer: 10 mM Phosphate, 138mM NaCl, 2.67 mM KCl, pH 7.4	50 Pcs/PK
TBS-50	TBS Buffer: 50mM Tris-HCl, 138 mM NaCl, 2.7 mM KCl, pH 8.0	50 Pcs/PK
TG-50	Tris-Glycine Buffer: 25 mM Tris, 192 mM Glycine	50 Pcs/PK
TGS-50	Tris-Glycine-SDS Buffer: 25 mM Tris, 192 mM Glycine, 0.1% SDS	50 Pcs/PK
MOPS-50	Tris-MOPS-SDS Buffer: 50 mM MOPS, 50 mM Tris, 0.1% SDS, 1 mM EDTA	50 Pcs/PK
MES-50	Tris-MES-SDS Buffer: 50 mM MES, 50 mM Tris, 0.1% SDS, 1 mM EDTA	50 Pcs/PK
WTB-50	Western Blot Transfer Buffer: 48 mM Tris, 39 mM Glycine, 1.2 mM SDS	50 Pcs/PK
TE10-50	Tris-EDTA Buffer: 100 mM Tris-HCl, 10 mM EDTA, pH 7.4	50 Pcs/PK
SSC-50	SSC Buffer: 300 mM NaCl, 30 mM Trisodium citrate, pH 7.0	50 Pcs/PK
TAE-50	TAE Buffer: 40 mM Tris-Acetate, 1 mM EDTA, pH 8.0	50 Pcs/PK



## Biological Buffers

The biological buffers are applied to cell culture, immunohistochemistry (IHC), Western Blot, enzyme-linked immunosorbent assay (ELISA), in situ hybridization, immunodetection washing solutions, antibody dilutions, and molecular cloning fields.

### Features

- Sterilized by 0.1 µm filtration
- GMP standard, traceable throughout the process

## Ordering Information

Cat. #	Description	Qty.
PBS-EC500	PBS Buffer, pH 7.4, 500 mL, 1×	10 Bottle/Box
PBST-E500	PBS Tween-20 Buffer, 500 mL, 1×	10 Bottle/Box
DPBS-E500	DPBS Buffer, no calcium, no magnesium, 500 mL, 1×	10 Bottle/Box
TBS-E500	TBS Buffer, 500 mL, 1×	10 Bottle/Box
TBST-E500	TBS Tween-20 Buffer, 500 mL, 1×	10 Bottle/Box
TG-E500	Tris-Glycine Buffer, 500 mL, 1×	10 Bottle/Box
TE-E500	Tris-EDTA Buffer, 500 mL, 1×	10 Bottle/Box
TGS-E500	Tris-Glycine SDS Buffer, 500 mL, 1×	10 Bottle/Box
WTB-E500	Western Transfer Buffer, 500 mL, 1×	10 Bottle/Box







## Laboratory Filtration Consumables

05

## UHMW-PE Frits Introduction

biocomma® UHMW-PE Frits are made from high purity ultra-high molecule weight polyethylene (UHMW-PE).

### Material Characteristics

#### ◇ Material

UHMW-PE is a polymeric material with molecular weight > 1,500,000 Da.

In addition to its superior resistance to mechanical impact, abrasion, low temperature and good self-lubrication, UHMW-PE has other outstanding properties such as:

- Excellent resistance to corrosive chemicals—It is resistant to many corrosive chemicals (acids, bases, salts) as well as numerous organic solvents.
- Non-toxicity: Due to its biological inertia and physiological compatibility, UHMW-PE has been approved by JHPIA (Japan Hygiene Products Industry Association), US FDA (United States Food and Drug Administration) and USDA (United States Department of Agriculture) for direct contact with foods and drugs. There are successful attempts to use replacement components based on UHMW-PE as implants in human.
- Excellent hydrophobicity: It shows an extremely low moisture absorption (< 0.01%), much better than Nylon 66 (1%). It is the lowest moisture absorption material among engineering plastics.

#### ◇ Particle Size

In general, the particle of UHMW-PE is not a spherical structure, however it is very close to spherical shape. The more uniform the particle is, the better the sintered frits are.

Biocomma sets rigorous screening standards for raw materials and selects the pure UHMW-PE with uniform particle size distribution for our sintered frits.



Non-uniform particles

Uniform particles

Uniform and spherical particles

#### ◇ Purity

Biocomma uses highly pure and ultra-pure raw materials. Highly pure materials are selected by chromatography analysis, and ultra-pure materials are processed by reflux using several organic solvents.

Ultra-pure frits are widely used in highly sensitive chromatography analysis, such as solid phase extraction (SPE).

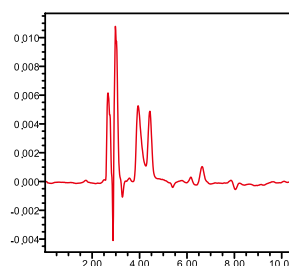

HPLC analysis of ordinary frits

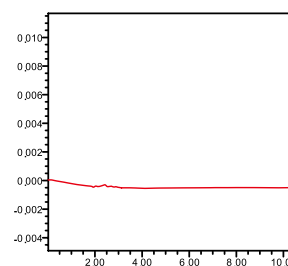

HPLC analysis of ultra-pure frits

### Specifications

#### ◇ Diameter

Sintered UHMW-PE frits are available in forms of disks and sheets. Diameters of disks range from 1.0-100 mm.

#### ◇ Thickness

Frits are available with a broad range of thicknesses, including 1.2 mm, 1.6 mm, 2.5 mm, 3.2 mm, 3.5 mm, 4.0 mm, 5.0 mm, 6.0 mm, 7.0 mm, and 9.0 mm.

The most commonly used thicknesses are 1.6 mm and 2.5 mm. The ultra-thin frits (1.2 mm) are best-in-class.

#### ◇ Pore Size

There are maze-like pores with an average pore size from 5-100 μm, including 5 μm, 10 μm, 20 μm, 50 μm, 80 μm, and 100 μm.

The most commonly used pore sizes are 20 μm and 50 μm.

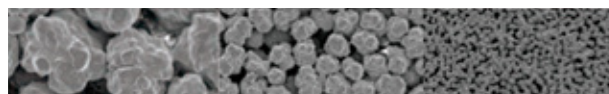

Pore size 80 μm

Pore size 20 μm

Pore size 3-5 μm

## Properties

### ◇ Hydrophobicity

Standard hydrophobic and hydrophilic formulations are available to your needs.

Our sintered UHMW-PE frits are natively hydrophobic, while hydrophilic frits are processed through surface modification. Compared with others, Biocomma's hydrophilic frits have some unique advantages such as low protein adsorption. It is not easy to form air bubbles inside the hydrophilic frits, otherwise air bubbles would reduce sample flowrate and influence the effect of purification.

Left: water could infiltrate hydrophilic frits  
Right: water could not infiltrate hydrophobic frits unless there is pressure.

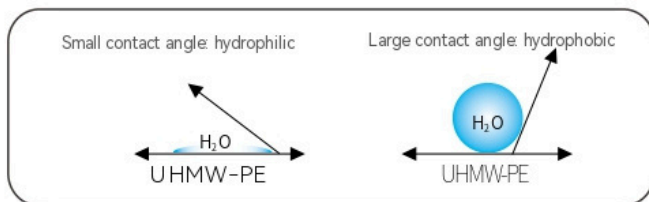

### ◇ Stable Flowrate

In order to deliver the best reproducibility from batch to batch, UHMW-PE frits are optimized in dimensions, porosity and air resistance. For example, by optimizing pore size, we manage to obtain flowrate of 1-2 drops per second, which is ideal for gravity-flow purification of proteins and nucleic acids.

### ◇ DNase/RNase/PCR Inhibitor Free

Biocomma provides UHMW-PE frits free of DNase/RNase/PCR inhibitor, and our strict technical standard and rigorous laboratories test ensure the frits have wide applications in biological labs, including PCR, DNA/RNA extraction and etc.

In the sensitive molecule biology applications, if the frits contain DNase/RNase, DNA/RNA would be degraded. if they contain PCR inhibitor, PCR analysis would be affected.

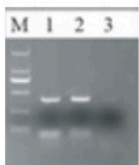

M: PCR marker  
1: Negative control  
2: Sample  
3: Positive control

As we can see an obvious difference in the electropherogram, if there was RNase in the frits, the extracted RNA would be degraded and be unable to reverse transcript into full-length cDNA, which would result a remarkable decrease in the yield of PCR products.

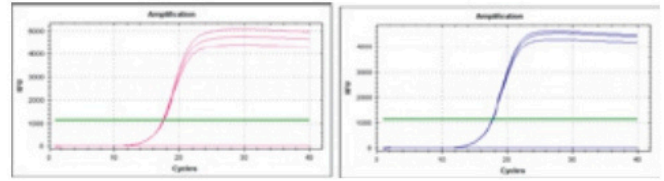

qRT-PCR analysis shows CT difference between test (right) and control (left) is plus or minus two, which substantiates the frits free of PCR inhibitor.

## Ordering Guidelines

Take into account sorbent, solvent and other factors depending on the application when selecting the frits. Here are some pro-fessional advices from Biocomma.

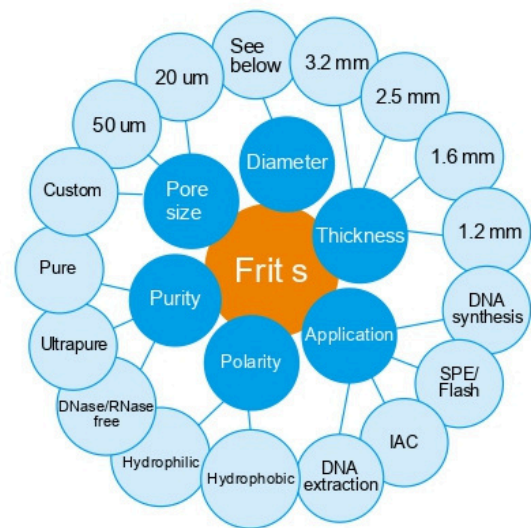

### ◇ Materials

PE is one of the most commonly used polymers in the world, sintered UHMW-PE frits could meet general applications requirements in life science and chemistry analysis. For special applications, Biocomma provides other frits made from PP, PTFE, glass fibers, composite materials and etc.

### ◇ Purity

biocomma® UHMW-PE Frits are all made from pure UHMW-PE. We recommend ultra-pure frits for highly sensitive chromatography analysis and DNase/RNase/PCR inhibitor free frits for molecule biology applications.

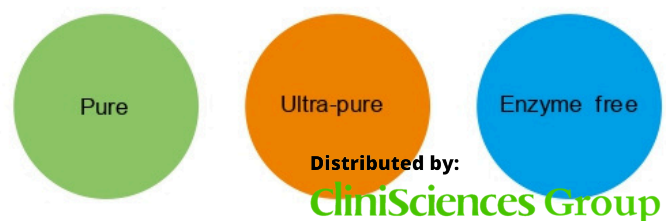



◇ Diameter

Available in 1.0-100 mm, appropriate diameter sizes can be selected according to a certain application.

◇ Thickness

In many applications, frits offer support for sorbent or medium. Generally, with larger thickness, frits could offer better support but result in slower flow rate. Therefore, it is necessary to optimize and balance the thickness and flow rate in practical needs.

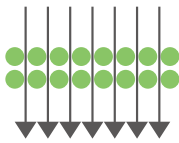

Thinner frits,  
faster flow

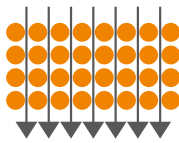

Thicker frits,  
slower flow,  
better support

◇ Hydrophobicity

Hydrophobic frits are commonly used in organic solvents, while hydrophilic frits are usually used in aqueous solution.

◇ Pore size

It is suggested that pore size of frits should be less than 1/2 of particle size of sorbent or medium. For example, if the particle size of a sorbent is more than 40  $\mu\text{m}$ , it is strongly recommended to use frits of 20  $\mu\text{m}$ .

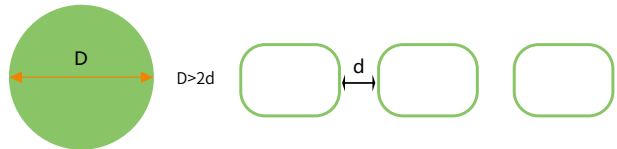

◇ Application

biocomma® UHMW-PE Frits are optimized for use in separation, chromatography, SPE, affinity chromatography and DNA/RNA purification/extraction, solid phase synthesis applications.



## Hydrophobic Frits

Sintered UHMW-PE frits are usually hydrophobic.

As shown below, Biocomma provides various sizes:

Thickness: 1.2 mm (1/20"), 1.6 mm (1/16"), 2.5 mm (1/10"), 3.2 mm (1/8") and other customised thickness.

Pore size: 5 µm, 10 µm, 20 µm, 50 µm, 80 µm and the other customised pore size.

Diameter: please refer to order information.



### Ordering Information

Cat. #	Diameter (mm)	Thickness (mm)	Pore Size (µm)	Qty.
BF014-12-20	1.4	1.2	20	1000 Pcs/PK
BF021-16-20	2.1	1.6	20	1000 Pcs/PK
BF025-16-20	2.5	1.6	20	1000 Pcs/PK
BF025-25-20	2.5	2.5	20	1000 Pcs/PK
BF025-25-50	2.5	2.5	50	1000 Pcs/PK
BF025-40-50	2.5	4.0	50	1000 Pcs/PK
BF041-16-20	4.1	1.6	20	1000 Pcs/PK
BF041-25-20	4.1	2.5	20	1000 Pcs/PK
BF041-32-80	4.1	3.2	80	1000 Pcs/PK
BF046-16-20	4.6	1.6	20	1000 Pcs/PK
BF047-16-20	4.7	1.6	20	1000 Pcs/PK
BF048-32-05	4.8	3.2	5	1000 Pcs/PK
BF049-16-20	4.9	1.6	20	1000 Pcs/PK
BF058-16-20	5.8	1.6	20	1000 Pcs/PK
BF058-16-50	5.8	1.6	50	1000 Pcs/PK
BF060-16-20	6.0	1.6	20	1000 Pcs/PK
BF064-32-10	6.4	3.2	10	1000 Pcs/PK
BF066-12-20	6.6	1.2	20	1000 Pcs/PK
BF066-16-02	6.6	1.6	2	1000 Pcs/PK
BF066-16-20	6.6	1.6	20	1000 Pcs/PK
BF066-16-50	6.6	1.6	50	1000 Pcs/PK
BF066-25-20	6.6	2.5	20	1000 Pcs/PK
BF066-32-10	6.6	3.2	10	1000 Pcs/PK
BF070-16-02	7.0	1.6	2	1000 Pcs/PK
BF070-16-20	7.0	1.6	20	1000 Pcs/PK
BF071-16-02	7.1	1.6	2	1000 Pcs/PK
BF072-16-02	7.2	1.6	2	1000 Pcs/PK
BF072-16-20	7.2	1.6	20	1000 Pcs/PK
BF074-16-05	7.4	1.6	5	1000 Pcs/PK
BF074-16-20	7.4	1.6	20	1000 Pcs/PK
BF080-16-50	8.0	1.6	50	1000 Pcs/PK
BF083-16-20	8.3	1.6	20	1000 Pcs/PK
BF086-16-20	8.6	1.6	20	1000 Pcs/PK
BF086-16-50	8.6	1.6	50	1000 Pcs/PK
BF088-16-50	8.8	1.6	50	1000 Pcs/PK
BF090-16-05	9.0	1.6	5	1000 Pcs/PK
BF090-16-10	9.0	1.6	10	1000 Pcs/PK
BF090-16-20	9.0	1.6	20	1000 Pcs/PK
BF090-16-50	9.0	1.6	50	1000 Pcs/PK
BF090-16-80	9.0	1.6	80	1000 Pcs/PK
BF090-25-20	9.0	2.5	20	1000 Pcs/PK
BF091-16-20	9.1	1.6	20	1000 Pcs/PK
BF091-16-50	9.1	1.6	50	1000 Pcs/PK
BF091-25-20	9.1	2.5	20	1000 Pcs/PK
BF093-16-20	9.3	1.6	20	1000 Pcs/PK
BF093-25-20	9.3	2.5	20	1000 Pcs/PK
Custom frits				

Cat. #	Diameter (mm)	Thickness (mm)	Pore Size (µm)	Qty.
BF101-16-20	10.1	1.6	20	1000 Pcs/PK
BF101-25-20	10.1	2.5	20	1000 Pcs/PK
BF105-16-20	10.5	1.6	20	1000 Pcs/PK
BF110-16-20	11.0	1.6	20	1000 Pcs/PK
BF110-25-20	11.0	2.5	20	1000 Pcs/PK
BF122-16-20	12.2	1.6	20	1000 Pcs/PK
BF124-25-20	12.4	2.5	20	1000 Pcs/PK
BF125-16-50	12.5	1.6	50	1000 Pcs/PK
BF127-16-50	12.7	1.6	50	1000 Pcs/PK
BF127-25-20	12.7	2.5	20	1000 Pcs/PK
BF130-16-10	13.0	1.6	10	1000 Pcs/PK
BF130-16-20	13.0	1.6	20	1000 Pcs/PK
BF130-16-50	13.0	1.6	50	1000 Pcs/PK
BF130-25-05	13.0	2.5	5	1000 Pcs/PK
BF130-25-10	13.0	2.5	10	1000 Pcs/PK
BF130-25-20	13.0	2.5	20	1000 Pcs/PK
BF130-25-50	13.0	2.5	50	1000 Pcs/PK
BF132-16-20	13.2	1.6	20	1000 Pcs/PK
BF142-16-20	14.2	1.6	20	1000 Pcs/PK
BF151-16-50	15.1	1.6	50	1000 Pcs/PK
BF151-25-20	15.1	2.5	20	1000 Pcs/PK
BF159-25-20	15.9	2.5	20	1000 Pcs/PK
BF162-25-20	16.2	2.5	20	1000 Pcs/PK
BF193-25-20	19.3	2.5	20	1000 Pcs/PK
BF196-32-10	19.6	3.2	10	1000 Pcs/PK
BF196-35-10	19.6	3.5	10	1000 Pcs/PK
BF197-16-20	19.7	1.6	20	1000 Pcs/PK
BF197-25-20	19.7	2.5	20	1000 Pcs/PK
BF221-25-20	22.1	2.5	20	1000 Pcs/PK
BF228-16-50	22.8	1.6	50	1000 Pcs/PK
BF228-25-20	22.8	2.5	20	1000 Pcs/PK
BF236-16-20	23.6	1.6	20	1000 Pcs/PK
BF236-25-20	23.6	2.5	20	1000 Pcs/PK
BF240-25-20	24.0	2.5	20	1000 Pcs/PK
BF264-25-20	26.4	2.5	20	1000 Pcs/PK
BF273-32-05	27.3	3.2	5	1000 Pcs/PK
BF291-16-20	29.1	1.6	20	1000 Pcs/PK
BF292-16-20	29.2	1.6	20	1000 Pcs/PK
BF292-16-50	29.2	1.6	50	1000 Pcs/PK
BF293-16-20	29.3	1.6	20	1000 Pcs/PK
BF293-16-50	29.3	1.6	50	1000 Pcs/PK
BF293-16-80	29.3	1.6	80	1000 Pcs/PK
BF296-25-20	29.6	2.5	20	1000 Pcs/PK
BF380-25-20	38.0	2.5	20	100 Pcs/PK
BF495-16-50	49.5	1.6	50	100 Pcs/PK
BF495-25-20	49.5	2.5	20	100 Pcs/PK
BF510-25-20	51.0	2.5	20	100 Pcs/PK
Custom frits				



## Hydrophilic Frits

Hydrophilic frits are processed through surface modification of hydrophobic frits.

As shown below, Biocomma provides various sizes:

Thickness: 1.2 mm (1/20"), 1.6 mm (1/16"), 2.5 mm (1/10") and other customised thickness.

Pore size: 20 µm, 50 µm and the other customised pore size.

Diameter: please refer to order information.

### Ordering Information

Cat. #	Diameter (mm)	Thickness (mm)	Pore Size (µm)	Qty.
LF014-12-20	1.4	1.2	20	1000 Pcs/PK
LF016-16-50	1.6	1.6	50	1000 Pcs/PK
LF025-16-50	2.5	1.6	50	1000 Pcs/PK
LF040-16-50	4.0	1.6	50	1000 Pcs/PK
LF058-16-50	5.8	1.6	50	1000 Pcs/PK
LF066-16-50	6.6	1.6	50	1000 Pcs/PK
LF072-16-50	7.2	1.6	50	1000 Pcs/PK
LF074-16-20	7.4	1.6	20	1000 Pcs/PK
LF074-16-50	7.4	1.6	50	1000 Pcs/PK
LF080-16-50	8.0	1.6	50	1000 Pcs/PK
LF090-16-50	9.0	1.6	50	1000 Pcs/PK
LF091-16-50	9.1	1.6	50	1000 Pcs/PK
LF093-16-50	9.3	1.6	50	1000 Pcs/PK
LF125-16-50	12.5	1.6	50	1000 Pcs/PK
LF127-16-50	12.7	1.6	50	1000 Pcs/PK
LF130-16-50	13.0	1.6	50	1000 Pcs/PK
LF151-16-50	15.1	1.6	50	1000 Pcs/PK
LF197-16-50	19.7	1.6	50	1000 Pcs/PK
LF228-16-50	22.8	1.6	50	1000 Pcs/PK
LF236-16-50	23.6	1.6	50	1000 Pcs/PK
LF273-25-50	27.3	2.5	50	1000 Pcs/PK
LF292-16-50	29.2	1.6	50	1000 Pcs/PK
LF296-25-50	29.6	2.5	50	1000 Pcs/PK
LF495-16-50	49.5	1.6	50	100 Pcs/PK
LF510-16-50	51.0	1.6	50	100 Pcs/PK
Custom frits				



## Polypropylene Fiber Frits

biocomma® polypropylene fiber frits are made from polypropylene fiber, resistant to acids, bases and most organic solvents, has low absorption for most biological macromolecules. These frits are commonly used in biological applications.

### Ordering Information

Cat. #	Diameter (mm)	Thickness (mm)	Pore Size (µm)	Qty.
F-PP-060-1	6.0	1.0	5	1000 Pcs/PK
F-PP-066-1	6.6	1.0	5	1000 Pcs/PK
F-PP-072-1	7.2	1.0	5	1000 Pcs/PK
F-PP-078-1	7.85	1.0	5	1000 Pcs/PK
F-PP-080-1	8.0	1.0	5	1000 Pcs/PK
F-PP-090-1	9.0	1.0	5	1000 Pcs/PK
F-PP-162-1	16.2	1.0	5	1000 Pcs/PK
F-PP-171-1	17.1	1.0	5	1000 Pcs/PK
Custom frits				



## Filtration Cartridges

biocomma® filtration cartridges are used to perform a range of filtration operation. Each filtration cartridge contains one cartridges tube, a single 20 µm PE frit or 50 µm hydrophilic frit. These cartridges provide an easy-to-use filtration method for quick and easy removal.

### Features

- Available from 1 mL to 300 mL
- Medical-grade polypropylene tubes with Luer outlets
- Sintered UHMW-PE frits with excellent solvent compatibility
- Suitable for vacuum

### Ordering Information

Cat. #	Description	Qty.
CTF001-BC-1	1 mL Filtration Cartridges, with one 20 µm Frit	500 Pcs/PK
CTF003-BC-1	3 mL Filtration Cartridges, with one 20 µm Frit	200 Pcs/PK
CTF006-BC-1	6 mL Filtration Cartridges, with one 20 µm Frit	100 Pcs/PK
CTF012-BC-1	12 mL Filtration Cartridges, with one 20 µm Frit	100 Pcs/PK
CTF020-SL-1	20 mL Filtration Cartridges, with one 20 µm Frit	50 Pcs/PK
CTF030-SL-1	30 mL Filtration Cartridges, with one 20 µm Frit	50 Pcs/PK
CTF060-BC-1	60 mL Filtration Cartridges, with one 20 µm Frit	50 Pcs/PK
CTF150-BC-1	150 mL Filtration Cartridges, with one 20 µm Frit	20 Pcs/PK
CTF300-BC-1	300 mL Filtration Cartridges, with one 20 µm Frit	10 Pcs/PK

Note: Please contact us for more specifications.



## Paper Filters

biocomma® Paper Filters with plastic brackets are molded from filter paper and polyethylene, with a higher filtration surface area, suitable for gravity-flow filtration of viscous liquid such as bacterial cell lysate. When the paper filter (25 mL) is used together with plasmid maxiprep column (RS30-2), it takes about 5 minutes to filter 20 mL lysate.

### Features

- High filtration surface and rapid filtration by gravity
- Insoluble in aqueous solutions for a long time
- Resistant to common acids, bases and organic solvents

### Ordering Information

Cat. #	Description	Qty.
004412-1	Paper Filters, 25 mL	25 Pcs/PK

Note: Please contact us for more specifications.



## Empty Straight-Barrel Tubes

biocomma® Empty Straight-Barrel Tubes are made from medical-grade polypropylene (PP), with Luer-outlet at the bottom. After packing with appropriate sorbents / resins, these tubes are used in applications such as solid-phase extraction (SPE), affinity chromatography (AC) and solid-phase synthesis.

### Features

- Available volumes from 1 mL to 300 mL
- Optional accessories: upper caps, bottom caps, fixing rings, frits (hydrophilic or hydrophobic)

### Ordering Information

Cat. #	Description	Qty.
CT001-BC-1	1 mL Empty Straight-Barrel Tubes	500 Pcs/PK
CT003-BC-1	3 mL Empty Straight-Barrel Tubes	200 Pcs/PK
CT006-BC-2	6 mL Empty Straight-Barrel Tubes	100 Pcs/PK
CT012-BC-1	12 mL Empty Straight-Barrel Tubes	100 Pcs/PK
CT020-SL-2	20 mL Empty Straight-Barrel Tubes	50 Pcs/PK
CT030-SL-2	30 mL Empty Straight-Barrel Tubes	50 Pcs/PK
CT030-SZ-1	30 mL Empty Straight-Barrel Tubes	50 Pcs/PK
CT060-BC-2	60 mL Empty Straight-Barrel Tubes	50 Pcs/PK
CT150-BC-1	150 mL Empty Straight-Barrel Tubes	20 Pcs/PK
CT300-BC-2	300 mL Empty Straight-Barrel Tubes	10 Pcs/PK



Distributed by:

CliniSciences Group

## Empty Luer-Inlet Tubes

biocomma® Empty Luer-Inlet Tubes are made from medical-grade polypropylene (PP), with Luer-inlet at the top and Luer-outlet at the bottom, ideal for tandem applications.

### Ordering Information

Cat. #	Description	Qty.
CT001-JY-N-1	1 mL Empty Luer-Inlet Tubes	1000 Pcs/PK



## Empty Rimless Tubes

biocomma® Empty Rimless Tubes are made from medical-grade polypropylene (PP) and with Luer-outlet at the bottom. After packing with appropriate sorbents / resins, these tubes are used in applications such as solid-phase extraction (SPE), affinity chromatography (AC) and solid-phase synthesis.

### Features

- Rimless design are useful for compact figurations in high through pvt systems
- Available volumes: 1 mL, 3 mL, 6 mL, 12 mL
- Optional accessories: fixing rings, frits (hydrophilic or hydrophobic)

### Ordering Information

Cat. #	Description	Qty.
NT001-1	1 mL Empty Rimless Tubes	100 Pcs/PK
NT003-1	3 mL Empty Rimless Tubes	100 Pcs/PK
NT006-1	6 mL Empty Rimless Tubes	100 Pcs/PK
NT012-1	12 mL Empty Rimless Tubes	100 Pcs/PK



## Connectors

The step cone-shaped and Luer inlet design ensure the connectors are suitable for 1, 3, 6, 12 mL cartridges, especially for tandem extraction.

### Ordering Information

Cat. #	Description	Qty.
CS000-TJ-10	Connectors, for 1/3/6/12 mL Cartridges	10 Pcs/PK
CS003-JY-1	Connectors, for 3 mL Cartridges	100 Pcs/PK



## Flow Regulators

Flow regulators are suitable for connecting with vacuum manifolds to control flowrate and pressure, each with one Luer inlet and one Luer outlet.

### Ordering Information

Cat. #	Description	Qty.
CS002-PP-100	Flow Regulators	100 Pcs/PK



## Upper and Bottom Caps

Upper and bottom caps are useful for preserving prepacked cartridges. Upper caps are suitable for cartridges of different sizes respectively, and bottom caps are universal for all cartridges.

### Ordering Information

Cat. #	Description	Qty.
UC001-BC-1	Upper caps, for 1 mL Cartridges, Red	1000 Pcs/PK
UC001-BC-G-1	Upper caps, for 1 mL Cartridges, Green	1000 Pcs/PK
UC001-BC-O-1	Upper caps, for 1 mL Cartridges, Orange	1000 Pcs/PK
UC001-BC-W-1	Upper caps, for 1 mL Cartridges, White	1000 Pcs/PK
UC003-BC-O-1	Upper caps, for 3 mL Cartridges, Orange	100 Pcs/PK
UC003-BC-W-1	Upper caps, for 3 mL Cartridges, White	100 Pcs/PK
UC003-BC-G-1	Upper caps, for 3 mL Cartridges, Green	100 Pcs/PK
UC003-BC-N-1	3 mL Luer-Inlet Upper Caps, Red	1000 Pcs/PK
UC003-BC-PW-1	3 mL Luer-lock pierceable upper caps, clear	1000 Pcs/PK
UC006-BC-2	Upper caps, for 6 mL Cartridges, Red	1000 Pcs/PK
UC012-BC-1000	Upper caps, for 12 mL Cartridges, Red	1000 Pcs/PK
UC030-SZ-2	Upper caps, for 30 mL Cartridges, Orange	1000 Pcs/PK
UC060-BC-2	Upper caps, for 60 mL Cartridges, Red	1000 Pcs/PK
UC150-BC-1	Upper caps for 150 mL cartridges, red	100 Pcs/PK
UC300-BC-1	Upper caps for 300 mL cartridges, red	100 Pcs/PK
LC-1-BC-1000	Bottom Caps, for all Cartridges	1000 Pcs/PK





## Micro Centrifugal Filters

### Features

- Particularly designed for standard benchtop micro centrifuges
- Filter bacteria, particles and cells to prepare HPLC samples, and remove DNA from agarose or acrylamide gels

### Ordering Information

Cat. #	Description	Qty.
FC0015-CA-22	2.0 mL Centrifugal Filters, hydrophilic CA, 0.22 $\mu\text{m}$	50 Sets/PK
FC0015-PVDF-22	2.0 mL Centrifugal Filters, organic PVDF, 0.22 $\mu\text{m}$	50 Sets/PK
FC015-CA-22	15 mL Centrifugal Filters, hydrophilic CA, 0.22 $\mu\text{m}$	50 Sets/PK
FC015-PVDF-22	15 mL Centrifugal Filters, organic PVDF, 0.22 $\mu\text{m}$	50 Sets/PK
FC050-CA-22	50 mL Centrifugal Filters, hydrophilic CA, 0.22 $\mu\text{m}$	50 Sets/PK
FC050-PVDF-22	50 mL Centrifugal Filters, organic PVDF, 0.22 $\mu\text{m}$	50 Sets/PK
FC0015-CA-45	2.0 mL Centrifugal Filters, hydrophilic CA, 0.45 $\mu\text{m}$	50 Sets/PK
FC0015-PVDF-45	2.0 mL Centrifugal Filters, organic PVDF, 0.45 $\mu\text{m}$	50 Sets/PK
FC015-CA-45	15 mL Centrifugal Filters, hydrophilic CA, 0.45 $\mu\text{m}$	50 Sets/PK
FC015-PVDF-45	15 mL Centrifugal Filters, organic PVDF, 0.45 $\mu\text{m}$	50 Sets/PK
FC050-CA-45	50 mL Centrifugal Filters, hydrophilic CA, 0.45 $\mu\text{m}$	50 Sets/PK
FC050-PVDF-45	50 mL Centrifugal Filters, organic PVDF, 0.45 $\mu\text{m}$	50 Sets/PK

Note: Please contact us for more specifications.



## 24-Well Micro-Filter Plates

High capacity (up to 7 mL) meets the requirements of receptor binding analysis, protein binding determination, ELISPOT analysis, sample preparation, removal of fluorescent dyes, etc.

### Features

- No dead volume, high recovery
- Removable Guide plate and unique designed filter plate
- Use with negative pressure or centrifugal method
- Corresponding collection plate

### Ordering Information

Cat. #	Description	Qty.
M0024-PES-H-22	24-Well Micro-Filter Plate, 7ml, PES, 0.22 $\mu\text{m}$ , and a collection plate	2 Sets/PK
M0024-PES-45	24-Well Micro-Filter Plate, 7ml, PES, 0.45 $\mu\text{m}$ , and a collection plate	2 Sets/PK
M0024-CA-22	24-Well Micro-Filter Plate, 7ml, CA, 0.22 $\mu\text{m}$ , and a collection plate	2 Sets/PK
M0024-CA-45	24-Well Micro-Filter Plate, 7ml, CA, 0.45 $\mu\text{m}$ , and a collection plate	2 Sets/PK
M0024-PVDF-22	24-Well Micro-Filter Plate, 7ml, PVDF, 0.22 $\mu\text{m}$ , and a collection plate	2 Sets/PK
M0024-PVDF-45	24-Well Micro-Filter Plate, 7ml, PVDF, 0.45 $\mu\text{m}$ , and a collection plate	2 Sets/PK
M0024-MCE-22	24-Well Micro-Filter Plate, 7ml, MCE, 0.22 $\mu\text{m}$ , and a collection plate	2 Sets/PK
M0024-MCE-45	24-Well Micro-Filter Plate, 7ml, MCE, 0.45 $\mu\text{m}$ , and a collection plate	2 Sets/PK



## 96-Well Micro-Filter Plates

biocomma® 96-Well Micro-Filter Plates (50–250 µL) are precision injection molded of polystyrene and equipped with many different types and materials of filter membranes, such as polyvinylidene fluoride (PVDF), mixed cellulose (MCE), polytetrafluoroethylene (PTFE) and other microporous filter membranes. Seamless integration is achieved by individually sealed well and removable guide plate and collection plate.

### Ordering Information

Cat. #	Description	Qty.
M0096-MCE-45	96-Well Micro-Filter Plates, removable, hydrophilic MCE, 0.45 µm	10 Pcs/PK
M0096-MCE-22	96-Well Micro-Filter Plates, removable, hydrophilic MCE, 0.22 µm	10 Pcs/PK
M0096-PVDF-45	96-Well Micro-Filter Plates, removable, hydrophobic PVDF, 0.45 µm	10 Pcs/PK
M0096-PVDF-22	96-Well Micro-Filter Plates, removable, hydrophobic PVDF, 0.22 µm	10 Pcs/PK
M0096-PVDF-H-45	96-Well Micro-Filter Plates, removable, hydrophilic PVDF, 0.45 µm	10 Pcs/PK
M0096-PVDF-H-22	96-Well Micro-Filter Plates, removable, hydrophilic PVDF, 0.22 µm	10 Pcs/PK
M0096-PTFE-45	96-Well Micro-Filter Plates, removable, hydrophobic PTFE, 0.45 µm	10 Pcs/PK
M0096-PTFE-22	96-Well Micro-Filter Plates, removable, hydrophobic PTFE, 0.22 µm	10 Pcs/PK
M0096-PTFE-H-45	96-Well Micro-Filter Plates, removable, hydrophilic PTFE, 0.45 µm	10 Pcs/PK
M0096-PTFE-H-22	96-Well Micro-Filter Plates, removable, hydrophilic PTFE, 0.22 µm	10 Pcs/PK
MN096-CA-22	96-Well Micro-Filter Plate, nonremovable, hydrophilic CA, 0.22 µm	10 Pcs/PK
MN096-CA-45	96-Well Micro-Filter Plate, nonremovable, hydrophilic CA, 0.45 µm	10 Pcs/PK
MN096-MCE-22	96-Well Micro-Filter Plate, nonremovable, hydrophilic MCE, 0.22 µm	10 Pcs/PK
MN096-MCE-45	96-Well Micro-Filter Plate, nonremovable, hydrophilic MCE, 0.45 µm	10 Pcs/PK
MN096-NY-22	96-Well Micro-Filter Plate, nonremovable, hydrophilic Nylon, 0.22 µm	10 Pcs/PK
MN096-NY-45	96-Well Micro-Filter Plate, nonremovable, hydrophilic Nylon, 0.45 µm	10 Pcs/PK
MN096-PES-22	96-Well Micro-Filter Plate, nonremovable, hydrophilic PES, 0.22 µm	10 Pcs/PK
MN096-PTFE-22	96-Well Micro-Filter Plate, nonremovable, hydrophobic PTFE, 0.22 µm	10 Pcs/PK
MN096-PTFE-45	96-Well Micro-Filter Plate, nonremovable, hydrophobic PTFE, 0.45 µm	10 Pcs/PK
MN096-PTFE-H-22	96-Well Micro-Filter Plate, nonremovable, hydrophilic PTFE, 0.22 µm	10 Pcs/PK
MN096-PTFE-H-45	96-Well Micro-Filter Plate, nonremovable, hydrophilic PTFE, 0.45 µm	10 Pcs/PK
MN096-PVDF-22	96-Well Micro-Filter Plate, nonremovable, hydrophobic PVDF, 0.22 µm	10 Pcs/PK
MN096-PVDF-45	96-Well Micro-Filter Plate, nonremovable, hydrophobic PVDF, 0.45 µm	10 Pcs/PK
MN096-PVDF-H-22	96-Well Micro-Filter Plate, nonremovable, hydrophilic PVDF, 0.22 µm	10 Pcs/PK
MN096-PVDF-H-45	96-Well Micro-Filter Plate, nonremovable, hydrophilic PVDF, 0.45 µm	10 Pcs/PK

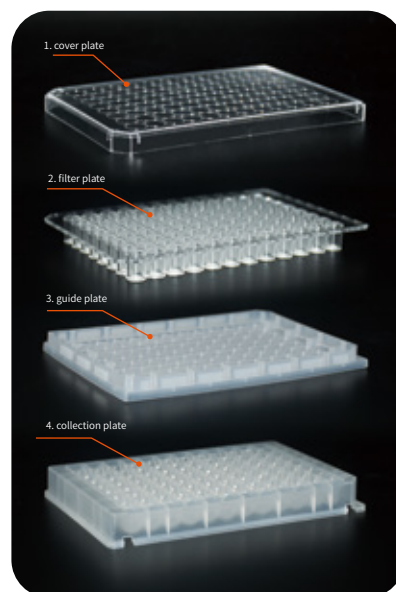

## Microfiltration Membranes

biocomma® Microfiltration Membranes are used in sample filtration during analysis process in laboratories.

### Ordering Information

#### Mixed Cellulose Ester (MCE) Microfiltration Membrane

Cat. #	Description	Qty.
MF047-22-MCE	MCE / $\Phi$ 47 mm / 0.22 $\mu$ m	200 Pcs/Box
MF047-45-MCE	MCE / $\Phi$ 47 mm / 0.45 $\mu$ m	200 Pcs/Box

#### Cellulose Acetate (CA) Microfiltration Membrane

Cat. #	Description	Qty.
MF047-22-CA	CA/ $\Phi$ 47 mm/0.22 $\mu$ m	200 Pcs/Box
MF047-45-CA	CA/ $\Phi$ 47 mm/0.45 $\mu$ m	200 Pcs/Box

#### Polyethersulfone (PES) Microfiltration Membrane

Cat. #	Description	Qty.
MF047-22-PES	PES/ $\Phi$ 47 mm/0.22 $\mu$ m	200 Pcs/Box
MF047-45-PES	PES/ $\Phi$ 47 mm/0.45 $\mu$ m	200 Pcs/Box

#### Hydrophilic Polytetrafluoroethylene (PTFE) Microfiltration Membrane

Cat. #	Description	Qty.
MF047-22-PTFE-HL	PTFE/ $\Phi$ 47 mm/0.22 $\mu$ m	200 Pcs/Box
MF047-45-PTFE-HL	PTFE/ $\Phi$ 47 mm/0.45 $\mu$ m	200 Pcs/Box

#### Nylon Microfiltration Membrane

Cat. #	Description	Qty.
MF047-22-NL	Nylon / $\Phi$ 47 mm / 0.22 $\mu$ m	200 Pcs/Box
MF047-45-NL	Nylon / $\Phi$ 47 mm / 0.45 $\mu$ m	200 Pcs/Box

#### Polyvinylidene Fluoride (PVDF) Microfiltration Membrane

Cat. #	Description	Qty.
MF047-22-PVDF	PVDF / $\Phi$ 47 mm / 0.22 $\mu$ m	200 Pcs/Box
MF047-45-PVDF	PVDF / $\Phi$ 47 mm / 0.45 $\mu$ m	200 Pcs/Box

#### Polytetrafluoroethylene (PTFE) Microfiltration Membrane

Cat. #	Description	Qty.
MF047-22-PTFE	PTFE / $\Phi$ 47 mm / 0.22 $\mu$ m	200 Pcs/Box
MF047-45-PTFE	PTFE / $\Phi$ 47 mm / 0.45 $\mu$ m	200 Pcs/Box

\*Customized diameter of listed membranes are available.



# Syringe Filters

biocomma® Syringe Filters are suitable for solution preparation, sterilization filtration and biological sample preparation.

## Ordering Information

### Mixed Cellulose Ester (MCE) Syringe Filters

Cat. #	Description	Qty.
SF130-22-MCE	MCE / $\Phi$ 13 mm / 0.22 $\mu$ m / Hydrophilic	100 Pcs/Box
SF130-45-MCE	MCE / $\Phi$ 13 mm / 0.45 $\mu$ m / Hydrophilic	100 Pcs/Box
SF250-22-MCE	MCE / $\Phi$ 25 mm / 0.22 $\mu$ m / Hydrophilic	100 Pcs/Box
SF250-45-MCE	MCE / $\Phi$ 25 mm / 0.45 $\mu$ m / Hydrophilic	100 Pcs/Box

### Cellulose Acetate (CA) Syringe Filters

Cat. #	Description	Qty.
SF130-22-CA	CA / $\Phi$ 13 mm / 0.22 $\mu$ m / Hydrophilic	100 Pcs/Box
SF130-45-CA	CA / $\Phi$ 13 mm / 0.45 $\mu$ m / Hydrophilic	100 Pcs/Box
SF250-22-CA	CA / $\Phi$ 25 mm / 0.22 $\mu$ m / Hydrophilic	100 Pcs/Box
SF250-45-CA	CA / $\Phi$ 25 mm / 0.45 $\mu$ m / Hydrophilic	100 Pcs/Box

### Hydrophilic Polytetrafluoroethylene (PTFE) Syringe Filters

Cat. #	Description	Qty.
SF130-22-PTFE-HL	PTFE / $\Phi$ 13 mm / 0.22 $\mu$ m / Hydrophilic	100 Pcs/Box
SF130-45-PTFE-HL	PTFE / $\Phi$ 13 mm / 0.45 $\mu$ m / Hydrophilic	100 Pcs/Box
SF250-22-PTFE-HL	PTFE / $\Phi$ 25 mm / 0.22 $\mu$ m / Hydrophilic	100 Pcs/Box
SF250-45-PTFE-HL	PTFE / $\Phi$ 25 mm / 0.45 $\mu$ m / Hydrophilic	100 Pcs/Box

### Hydrophilic Polyvinylidene Fluoride (PVDF) Syringe Filters

Cat. #	Description	Qty.
SF130-22-PVDF-HL	PVDF / $\Phi$ 13 mm / 0.22 $\mu$ m / Hydrophilic	100 Pcs/Box
SF130-45-PVDF-HL	PVDF / $\Phi$ 13 mm / 0.45 $\mu$ m / Hydrophilic	100 Pcs/Box
SF250-22-PVDF-HL	PVDF / $\Phi$ 25 mm / 0.22 $\mu$ m / Hydrophilic	100 Pcs/Box
SF250-45-PVDF-HL	PVDF / $\Phi$ 25 mm / 0.45 $\mu$ m / Hydrophilic	100 Pcs/Box

### Polyethersulfone (PES) Syringe Filters

Cat. #	Description	Qty.
SF130-22-PES	PES / $\Phi$ 13 mm / 0.22 $\mu$ m / Hydrophilic	100 Pcs/Box
SF130-45-PES	PES / $\Phi$ 13 mm / 0.45 $\mu$ m / Hydrophilic	100 Pcs/Box
SF250-22-PES	PES / $\Phi$ 25 mm / 0.22 $\mu$ m / Hydrophilic	100 Pcs/Box
SF250-45-PES	PES / $\Phi$ 25 mm / 0.45 $\mu$ m / Hydrophilic	100 Pcs/Box

### Polytetrafluoroethylene (PTFE) Syringe Filters

Cat. #	Description	Qty.
SF130-22-PTFE	PTFE / $\Phi$ 13 mm / 0.22 $\mu$ m / Hydrophobic	100 Pcs/Box
SF130-45-PTFE	PTFE / $\Phi$ 13 mm / 0.45 $\mu$ m / Hydrophobic	100 Pcs/Box
SF250-22-PTFE	PTFE / $\Phi$ 25 mm / 0.22 $\mu$ m / Hydrophobic	100 Pcs/Box
SF250-45-PTFE	PTFE / $\Phi$ 25 mm / 0.45 $\mu$ m / Hydrophobic	100 Pcs/Box

### Nylon Syringe Filters

Cat. #	Description	Qty.
SF130-22-NL	Nylon / $\Phi$ 13 mm / 0.22 $\mu$ m / Hydrophilic	100 Pcs/Box
SF130-45-NL	Nylon / $\Phi$ 13 mm / 0.45 $\mu$ m / Hydrophilic	100 Pcs/Box
SF250-22-NL	Nylon / $\Phi$ 25 mm / 0.22 $\mu$ m / Hydrophilic	100 Pcs/Box
SF250-45-NL	Nylon / $\Phi$ 25 mm / 0.45 $\mu$ m / Hydrophilic	100 Pcs/Box

### Polyvinylidene Fluoride (PVDF) Syringe Filters

Cat. #	Description	Qty.
SF130-22-PVDF	PVDF / $\Phi$ 13 mm / 0.22 $\mu$ m / Hydrophobic	100 Pcs/Box
SF130-45-PVDF	PVDF / $\Phi$ 13 mm / 0.45 $\mu$ m / Hydrophobic	100 Pcs/Box
SF250-22-PVDF	PVDF / $\Phi$ 25 mm / 0.22 $\mu$ m / Hydrophobic	100 Pcs/Box
SF250-45-PVDF	PVDF / $\Phi$ 25 mm / 0.45 $\mu$ m / Hydrophobic	100 Pcs/Box



## Sterile Syringe Filters

biocomma® Sterile Syringe Filters remove bacteria fast and reduce the impact on active ingredients in liquid during sterilization process. Generally, 0.1 µm syringe filter filters mycoplasma, 0.22 µm filters bacteria, and 0.45µm filters solid particles. Sterile syringe filters are widely applied to various fields of life science to sterilize small-volume biological liquids, such as proteins, culture media, additives, buffers, reagents, pharmaceuticals and etc.



### Features

- The easy tear packaging is made of medical polypropylene to ensure good sealing
- Sterilized by gamma radiation
- DNase and RNase free, pyrogen free and No Endotoxin
- Low protein adsorption rate

### Ordering Information

#### Sterile Mixed Cellulose Ester (MCE) Syringe Filters

Cat. #	Description	Qty.
SSF130-22-MCE	MCE / Φ13 mm / 0.22 µm / Hydrophilic	100 Pcs/PK
SSF130-45-MCE	MCE / Φ13 mm / 0.45 µm / Hydrophilic	100 Pcs/PK
SSF250-22-MCE	MCE / Φ25 mm / 0.22 µm / Hydrophilic	100 Pcs/PK
SSF250-45-MCE	MCE / Φ25 mm / 0.45 µm / Hydrophilic	100 Pcs/PK

#### Sterile Cellulose Acetate (CA) Syringe Filters

Cat. #	Description	Qty.
SSF130-22-CA	CA / Φ13 mm / 0.22 µm / Hydrophilic	100 Pcs/PK
SSF130-45-CA	CA / Φ13 mm / 0.45 µm / Hydrophilic	100 Pcs/PK
SSF250-22-CA	CA / Φ25 mm / 0.22 µm / Hydrophilic	100 Pcs/PK
SSF250-45-CA	CA / Φ25 mm / 0.45 µm / Hydrophilic	100 Pcs/PK

#### Sterile Polyethersulfone (PES) Syringe Filters

Cat. #	Description	Qty.
SSF130-22-PES	PES / Φ13 mm / 0.22 µm / Hydrophilic	100 Pcs/PK
SSF130-45-PES	PES / Φ13 mm / 0.45 µm / Hydrophilic	100 Pcs/PK
SSF250-22-PES	PES / Φ25 mm / 0.22 µm / Hydrophilic	100 Pcs/PK
SSF250-45-PES	PES / Φ25 mm / 0.45 µm / Hydrophilic	100 Pcs/PK

#### Sterile Polyvinylidene Fluoride (PVDF) Syringe Filters

Cat. #	Description	Qty.
SSF130-22-PVDF	PVDF / Φ13 mm / 0.22 µm / Hydrophobic	100 Pcs/PK
SSF130-45-PVDF	PVDF / Φ13 mm / 0.45 µm / Hydrophobic	100 Pcs/PK
SSF250-22-PVDF	PVDF / Φ25 mm / 0.22 µm / Hydrophobic	100 Pcs/PK
SSF250-45-PVDF	PVDF / Φ25 mm / 0.45 µm / Hydrophobic	100 Pcs/PK

#### Sterile Polytetrafluoroethylene (PTFE) Syringe Filters

Cat. #	Description	Qty.
SSF130-22-PTFE	PTFE / Φ13 mm / 0.22 µm / Hydrophobic	100 Pcs/PK
SSF130-45-PTFE	PTFE / Φ13 mm / 0.45 µm / Hydrophobic	100 Pcs/PK
SSF250-22-PTFE	PTFE / Φ25 mm / 0.22 µm / Hydrophobic	100 Pcs/PK
SSF250-45-PTFE	PTFE / Φ25 mm / 0.45 µm / Hydrophobic	100 Pcs/PK

#### Sterile Nylon Syringe Filter

Cat. #	Description	Qty.
SSF130-22-NL	Nylon / Φ13 mm / 0.22 µm / Hydrophilic	100 Pcs/PK
SSF130-45-NL	Nylon / Φ13 mm / 0.45 µm / Hydrophilic	100 Pcs/PK
SSF250-22-NL	Nylon / Φ25 mm / 0.22 µm / Hydrophilic	100 Pcs/PK
SSF250-45-NL	Nylon / Φ25 mm / 0.45 µm / Hydrophilic	100 Pcs/PK



## Sterile Filter Device

biocomma® Disposable Vacuum Filtration units are a standalone filtration unit that combines a graduated funnel-top, filter assembly and graduated reservoir. They are ideal for when a self-contained, pre-sterilized, disposable filtration unit is required. Can be used for the sterile filtration of biological and aqueous fluids, tissue culture media and buffers. Available with PES, cellulose acetate and PVDF membranes in various pore sizes, comes in two funnel sizes (250 and 500 ml) and three receiver flask (250, 500 and 1000 mL).



### Features

- Disposable and pre-sterilized by gamma irradiation for rapid and convenient use.
- Non-pyrogenic, low extractables and surfactant-free ensures purity of filtrate.
- Reservoir has textured areas for improved grip when handling and opening and sealing the bottle.
- Glass fiber pre-filter is available.

### Ordering Information

Cat.#	Description	Qty.
VFP050-010-PES-250	PES, $\Phi$ 50 mm, 0.1 $\mu$ m, 250 ml Funnel, 250 ml Receiver Flask, Sterile	12 Sets/Box
VFP050-022-PES-250	PES, $\Phi$ 50 mm, 0.22 $\mu$ m, 250 ml Funnel, 250 ml Receiver Flask, Sterile	12 Sets/Box
VFP050-045-PES-250	PES, $\Phi$ 50 mm, 0.45 $\mu$ m, 250 ml Funnel, 250 ml Receiver Flask, Sterile	12 Sets/Box
VFP090-010-PES-500	PES, $\Phi$ 90 mm, 0.1 $\mu$ m, 500 ml Funnel, 500 ml Receiver Flask, Sterile	12 Sets/Box
VFP090-022-PES-500	PES, $\Phi$ 90 mm, 0.22 $\mu$ m, 500 ml Funnel, 500 ml Receiver Flask, Sterile	12 Sets/Box
VFP090-045-PES-500	PES, $\Phi$ 90 mm, 0.45 $\mu$ m, 500 ml Funnel, 500 ml Receiver Flask, Sterile	12 Sets/Box
VFP090-010-PES-1000	PES, $\Phi$ 90 mm, 0.1 $\mu$ m, 1000 ml Funnel, 1000 ml Receiver Flask, Sterile	12 Sets/Box
VFP090-022-PES-1000	PES, $\Phi$ 90 mm, 0.22 $\mu$ m, 1000 ml Funnel, 1000 ml Receiver Flask, Sterile	12 Sets/Box
VFP090-045-PES-1000	PES, $\Phi$ 90 mm, 0.45 $\mu$ m, 1000 ml Funnel, 1000 ml Receiver Flask, Sterile	12 Sets/Box

Note: please contact for more specifications.

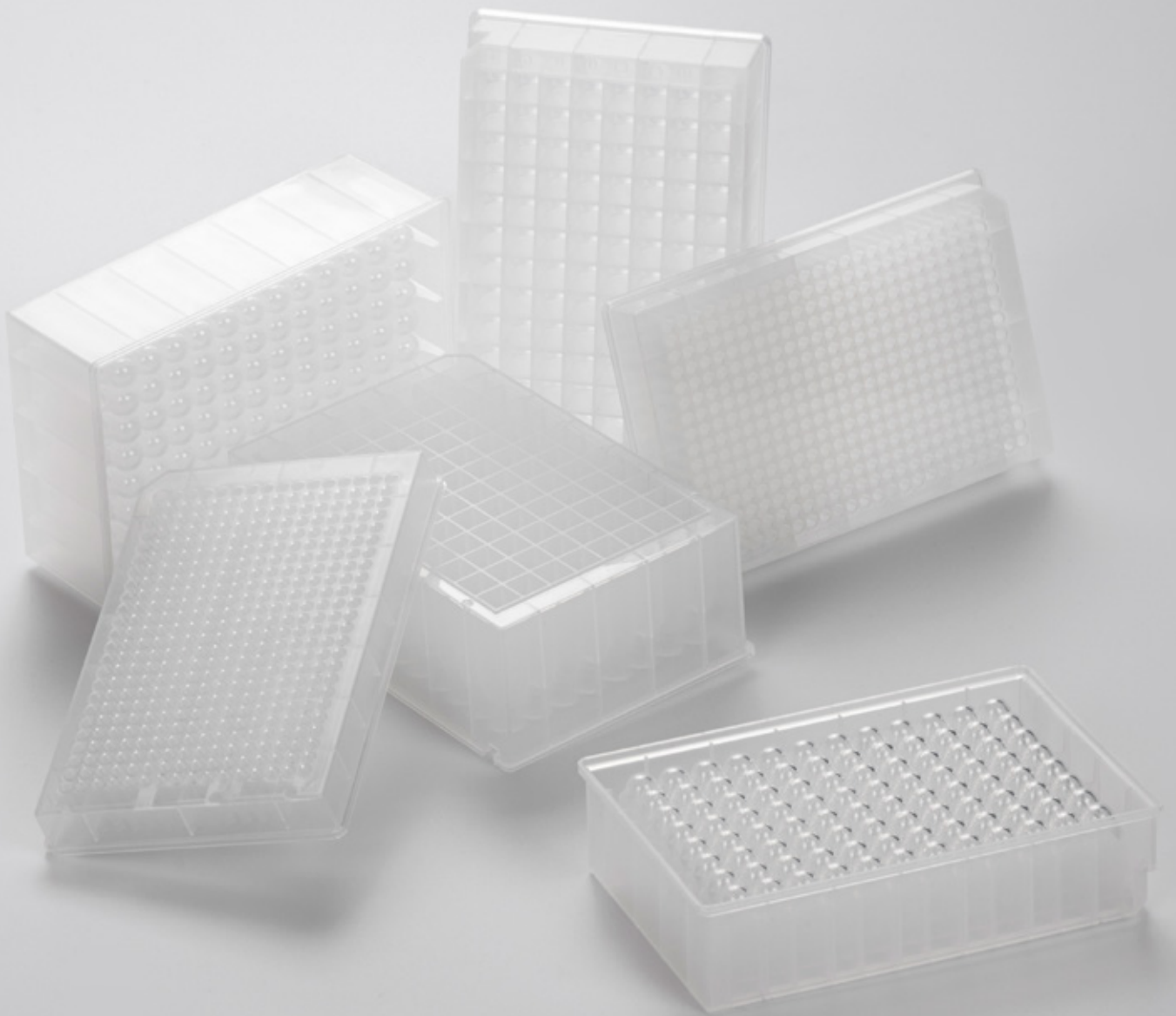

**General Laboratory  
Consumables**

06

## Collection Plates

biocomma® Collection Plates are molded from high-purity polypropylene (PP), which is highly stable. The outstanding properties are excellent solvent resistance (including DMSO, ethanol and isopropanol), thermally resistance and low residual. The collection plates are international ANSI/SBS standards-compliant design with alphabetical marks.

### Features

- Withstand high speed centrifugal force 3000-4000 g
- Tolerant to autoclave at 121 °C for 20 min
- 4.6/3.5/2.2/2.0/1.6/1.0 mL deep well plates and 0.4/0.36 mL microplates are available

### Ordering Information

#### Round Well:

Cat. #	Description	Qty.
48WP-C035	48-Well Collection Plate, Round Well, 3.5 mL, U-bottom	50 Pcs/Box
96WP-C020-N	96-Well Collection Plate, Round Well, 2.0 mL, U-bottom	24 Pcs/Box
96WP-C010	96-Well Collection Plate, Round Well, 1.0 mL, U-bottom	24 Pcs/Box
96WU-004	96-Well Collection Plate, Round Well, 0.4 mL, U-bottom	10 Pcs/Box
96WV-0036	96-Well Collection Plate, Round Well, 0.36 mL, V-bottom	10 Pcs/Box

#### Square Well:

Cat. #	Description	Qty.
48WP-S046	48-Well Collection Plate, Square Well, 4.6 mL, U-bottom	24 Pcs/Box
96WP-S022-BN	96-Well Collection Plate, Square Well, 2.2 mL, U-bottom	24 Pcs/Box
96WP-S022V-N	96-Well Collection Plate, Square Well, 2.2 mL, V-bottom	24 Pcs/Box
96WP-S016-BN	96-Well Collection Plate, Square Well, 1.6 mL, U-bottom	30 Pcs/Box
96WP-S010-N	96-Well Collection Plate, Square Well, 1.0 mL, U-bottom	30 Pcs/Box
384WP-240	384-Well collection plate, Square Well, 0.24 mL	10 Pcs/Box

Note: For sterilized collection plates, please contact us.

### ALL DIMENSIONS IN MM

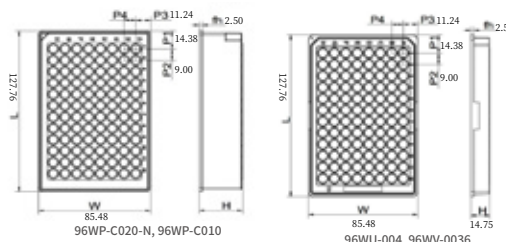
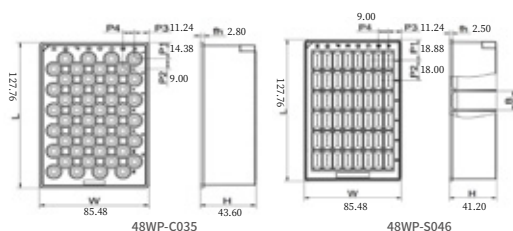

#### Note:

1.The length and width of round well plate of 96WP-C020-N and 96WP-C010 are the same, but the well height is 43.90 mm and 33.00 mm.

2.The length and width of square well plate of 96WP-S016-BN and 96WP-S010-N are the same, but the well height is 31.60 mm and 24.40 mm.

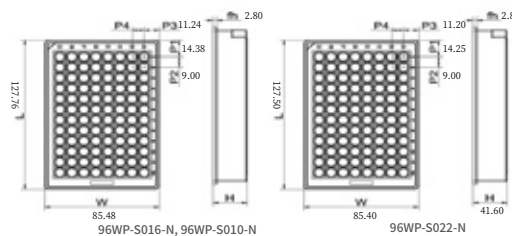

Distributed by:

CliniSciences Group

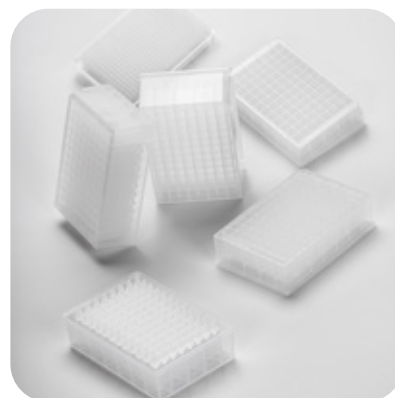

## Silicone Sealing Mats

### Ordering Information

Cat. #	Description	Qty.
96WSC20	96-Well Round Capped Silicone Sealing Mats, for Sealing 96-Well Collection Plates (2.0 mL), Pierceable	10 Pcs/PK
96WSC10	96-Well Round Capped Silicone Sealing Mats, for Sealing 96-Well Collection Plates (1.0/0.4/0.36 mL), Pierceable	10 Pcs/PK
96WSS	96-Well Square Capped Silicone Sealing Mats, for Sealing 96-Well Collection Plates (2.2/1.6/1.0 mL)	10 Pcs/PK
96WSP	96-Well Square Capped Silicone Sealing Mats, for Sealing 96-Well Collection Plates (2.2/1.6/1.0 mL), Pierceable	10 Pcs/PK
96WS	Adhesive Sealing Films, for Sealing Deep Well Plates	500 Pcs/PK

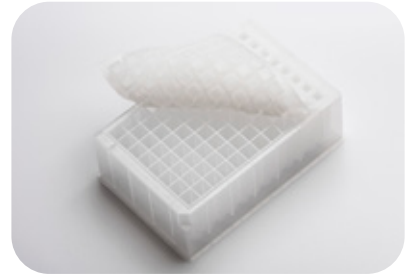

## Sealing Films

### Ordering Information

Cat. #	Description	Qty.
96WT-DC	Sealing Films, strong adhesive, highly optically clear, two easy removal white end tabs, 137*80 mm	100 Pcs/PK
96WT-DC-1	Sealing Films, pressure-sensitive, highly optically clear, two easy removal white end tabs, 140*80mm	100 Pcs/PK

Note: for more specifications, please contact us.

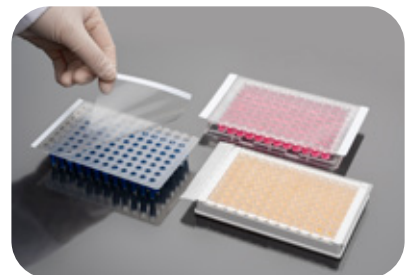

## Reagent Reservoirs

biocomma<sup>®</sup> Reagent Reservoirs are available in 8-channel, 12-channel, 96-channel and 384-channel, free of DNase and RNase.

### Ordering Information

Cat. #	Description	Qty.
8WR	8-Channel Reagent Reservoirs, 22 mL	10 Pcs/Box
12WR	12-Channel Reagent Reservoirs, 15 mL	10 Pcs/Box
96WR	96-Channel Reagent Reservoirs, 195mL	10 Pcs/Box
384WR	384-Channel Reagent Reservoirs, 185 mL	10 Pcs/Box



## Centrifuge Tubes

Medical-grade polypropylene, can withstand high speed centrifugation of 14,000 x g and autoclave at 121 ° C for 20 min.

### Ordering Information

Cat. #	Description	Qty.
SC-0015-CO-2	Centrifuge Tubes, 1.5 mL, with Lids	500 Pcs/PK
SC-002-CO-AJ-2	Centrifuge Tubes, 2.0 mL, with Lids	500 Pcs/PK
SC-002-CO-2	Centrifuge Tubes, 2.0 mL, special locking clasp	500 Pcs/PK
SC-002-O-RY-2	Centrifuge Tubes, 2.0 mL, without Lids	1000 Pcs/PK
SC-015	Centrifuge Tubes, 15 mL, with Lids	50 Pcs/PK
SC-050	Centrifuge Tubes, 50 mL, with Lids	50 Pcs/PK



## PCR Tube/Plate

- USP Class VI and FDA certified medical grade polypropylene raw materials
- Thin tube wall, fast heat transfer, precise temperature control
- Ultra-transparent tube cover design can ensure that the fluorescent signal can pass through without obstacles
- Good sealing performance of the tube cover, which prevents contamination, and is easy to open
- Autoclavable (121 °C sterilized for 20 min)
- DNA-free, DNase-free, RNase-free and pyrogen-free

### Ordering Information

Cat. #	Description	Qty.
ST005	0.5 mL, single PCR tube, transparent, flat cap	1000 Pcs/PK
4WT-001	0.1 mL, 4-strip PCR tube, transparent	250 Pcs/PK
8WT-001-CHN	0.1 mL, 8-strip PCR tube, transparent, 8-strip flat cap	125 Pcs/PK
8WT-002-CHN	0.2 mL, 8-strip PCR tube, transparent, 8-strip flat cap	125 Pcs/PK
8WT-001-1	0.1 mL, 8-strip PCR tube, transparent, 8-strip dome cap	125 Pcs/PK
8WT-002-1	0.2 mL, 8-strip PCR tube, transparent, 8-strip dome cap	125 Pcs/PK
8WT-001-2	0.1 mL, 8-strip PCR tube, transparent, attached individual cap	125 Pcs/PK
8WT-002-2	0.2 mL, 8-strip PCR tube, transparent, attached individual cap	125 Pcs/PK
8WT-001W	0.1 mL, 8-strip PCR tube, white, 8-strip flat cap	125 Pcs/PK
8WT-001W-1	0.1 mL, 8-strip PCR tube, white, 8-strip dome cap	125 Pcs/PK
8WT-002W-1	0.2 mL, 8-strip PCR tube, white, 8-strip flat cap	125 Pcs/PK
8WT-002W-2	0.2 mL, 8-strip PCR tube, white, 8-strip dome cap	125 Pcs/PK
96WT-001-N	0.1 mL, 96 well PCR Plate, transparent, non-skirt	25 Pcs/PK
96WT-001-H	0.1 mL, 96 Well PCR Plate, transparent, semi-skirt	25 Pcs/PK
96WT-001W-N	0.1 mL, 96 Well PCR Plate, white, non-skirt	25 Pcs/PK
96WT-001W-H	0.1 mL, 96 Well PCR Plate, white, semi-skirt	25 Pcs/PK
96WT-002-N	0.2 mL, 96 Well PCR Plate, transparent, non-skirt	25 Pcs/PK
96WT-002-H	0.2 mL, 96 Well PCR Plate, transparent, semi-skirt	25 Pcs/PK
96WT-002W-N	0.2 mL, 96 Well PCR Plate, white, non-skirt	25 Pcs/PK
96WT-002W-H	0.2 mL, 96 Well PCR Plate, white, semi-skirt	25 Pcs/PK
384WT-001-H	30 µL, 384 Well PCR Plate, transparent, full-skirt	25 Pcs/PK
384WT-001W-H	30 µL, 384 Well PCR Plate, white, full-skirt	25 Pcs/PK

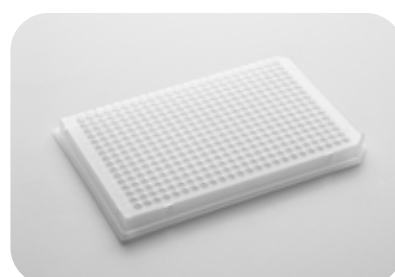
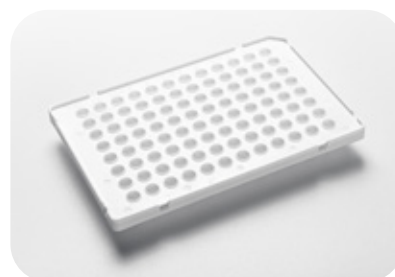

Distributed by:

CliniSciences Group



## ELISA Microplates

Enzyme Linked Immunosorbent Assay (ELISA) is a qualitative and quantitative detection method that binds soluble antigens or antibodies to a solid-phase carrier for immune reaction by specific binding of antigens and antibodies. ELISA is widely used in immunoassays because of its high detection sensitivity, strong specificity, safety and reliability.

biocomma® ELISA Microplates, as a solid-phase carrier in the experiment, is used to adsorb antigens, antibodies, or antigen-antibody complexes, which play a critical role in the overall experimental results.

### Features

- Designed for ELISA and compliant with ANS/SBS standards
- High signal-to-noise ratio
- Excellent protein adsorption capacity
- Good batch-to-batch stability
- Available with pinchbar or strip plates
- Flat bottom enables precise optical measurements

### Ordering Information

Cat. #	Description	Qty.
96EP-NBW	ELISA Microplates, pinchbar, clear	10 Pcs/PK, 20 PK/Ctn.
96EP-BKW	ELISA Microplates, strip plates, clear 8 strip, white frame	20 Pcs/PK, 20 PK/Ctn.

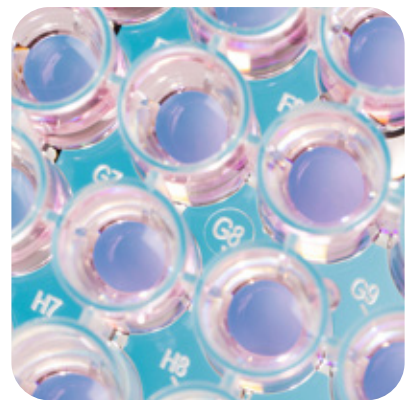
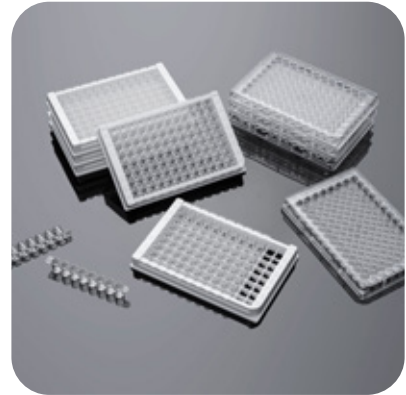

## Cell Culture Dishes

biocomma® Cell Culture Dishes as new generation dishes improve treatment, stacking and transportation of cell cultures in the laboratory. Raised outer edge and grip ring are designed to avoid sliding dishes and seamless stacking.

### Features

- Electron beam sterilization
- Vacuum-gas plasma treatment promotes cell attachment
- Clearly marked batch number is traceable
- Made of polystyrene which allow distortion-free microscopic observation
- Pyrogen-free, endotoxin-free

### Ordering Information

Cat. #	Description	Qty.
CCD-35	35 mm cell culture dish, vacuum-gas plasma treatment	10 Pcs/PK, 50 PK/Ctn.
CCD-60	60 mm cell culture dish, vacuum-gas plasma treatment	20 Pcs/PK, 25 PK/Ctn.
CCD-100	100 mm cell culture dish, vacuum-gas plasma treatment	10 Pcs/PK, 30 PK/Ctn.





Laboratory Equipment

07

## Nucleic Acid Extraction System

Based on magnetic beads separation method, the Automated Nucleic Acid Extraction Systems are widely applied to disease prevention and control, animal quarantine, clinical diagnosis, entry-exit inspection quarantine, food and drug administration, forensic identification, teaching and scientific research.



### Features

- **Anti-Pollution:** UV light and exhaust filtration reduce aerosols and volatile gases in the chamber
- **Programming:** visual touch operation, free program editing
- **Safety:** the instrument has the functions of power-on self-inspection, high temperature alarm, over-temperature protection, etc.
- **Open System:** compatible with all kinds of magnetic bead nucleic acid purification kits on the market

### Parameters

Model	M32	M48	N96
Throughput	1~32	1~48	1~96
Volume	20~1000 $\mu$ L	20~1000 $\mu$ L	5~1000 $\mu$ L
Consumables	96 well deep plate + 8 strip tip combs	96 well deep plate + 8 strip tip combs	96 well deep plate + 96 tip combs
Recovery	$\geq 99\%$	$\geq 99\%$	$\geq 99\%$
CV	< 5%	< 5%	< 5%
Humidity	10~90%	30~80%	10~80%
Temperature	10~40 $^{\circ}$ C	10~40 $^{\circ}$ C	10~40 $^{\circ}$ C
Controlling Temperature Range	RT ~ 80 $^{\circ}$ C	4~120 $^{\circ}$ C	4~120 $^{\circ}$ C , with over-temperature protection
Vibration	Level 1-3 adjustable	Level 1-3 adjustable	Optional 8, 16, 24, 32, 48, 96 modules
Sterilization	UV light, exhaust filtration	UV light, exhaust filtration	UV light + exhaust and HEPA filter
Reagents	Prepacked magnetic beads nucleic acid extraction kits	Prepacked magnetic beads nucleic acid extraction kits	Prepacked magnetic beads nucleic acid extraction kits
Interface	Integrated touch screen	Integrated touch screen	Integrated touch screen
Program	Create new, edit and delete	Create new, edit and delete	Create new, edit, load and delete
Port	USB	USB	USB, microcomputer system, external hardware
Dimensions (L*W*H)	400*420*440mm	500*460*540 mm	870*450*502 mm
Power Supply	A.C. 100~220 V, 3.15 A, 50/60 Hz	A.C. 100~199 V, 11A / 200~240 V, 6.5 A, 50/60 Hz	A.C. 110~240 V/20 VAC, 50/60 Hz, 350W
Weight	25 Kg	40 Kg	59 Kg

### Ordering Information

Cat. #	Description	Qty.
NAES-32	M32 Automated Nucleic Acid Extraction System	1 Set/Carton
NAES-48	M48 Automated Nucleic Acid Extraction System	1 Set/Carton
NAES-N96	N96 Automated Nucleic Acid Extraction System	1 Set/Carton

# Automated Sample Preparation System

## Preparation System

DC48 loads samples directly from collection tubes with automatic uncapping, sample addition, capping, barcode scanning, and PCR system establishment. This excellent solution for automation of nucleic acid sample preparation realizes auto monitoring of all process.



## Compatibility

- Automatically pipette liquids, and upload information by scanned barcode
- Adapt multiple collection tubes of 1, 3, 5, and 10 mL
- Support dispensing in deep well plates used for 16 or 96 tests
- Match common nucleic acid extraction systems of 32, 48, and 96 channels

## Safety

- Program controls the risk of error and omission. Full process monitoring prevent deviance
- Directional exhaust and HEPA filter create negative pressure, so external biological safety cabinet needed. Drip tray prevents pollution from accident drip
- The built-in UV lights in the experimental and waste cabin disinfect regularly
- Uncap one by one to prevent cross contamination

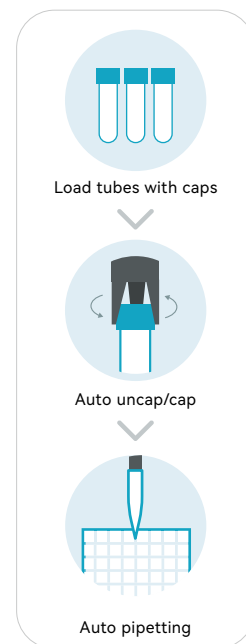

## Parameters

Model	DC48
Function	Auto uncap and cap, scan barcode, solution pipetting and dispensing
Throughput	1-48
CV Value	Below 15 $\mu$ L: CV $\leq$ 3%, 15-50 $\mu$ L: CV $\leq$ 1.5%, above 50 $\mu$ L: CV $\leq$ 1%
Pipetting Volume	5~1,000 $\mu$ L
Pipetting Channel	1 Channel
Pipetting System	Liquid level detection and following by air pressure, alarm when detect invalid aspiration and clogged needle The liquid surface follows the function
Collection Tubes	Adapt multiple size of 1, 3, 5, and 10 mL, support common vacuum blood collection tubes
Anti-Pollution	Directional exhaust and HEPA filter, built-in UV lamp, drip tray
Pipette Tips	2*96 pcs 1000ul tips or 96 pcs 1000ul + 96pcs 50ul tips
PCR Tubes	12 pcs PCR 8-strip tube, compatible with 0.1 and 0.2 ml, or 1 pc PCR 96-strip tube plate
Abnormal Alarm	Alarm reminds insufficient of reagents and consumables, supports addition midway
Program Setting	Free edition and large memory to store a variety of programs
Interface & Software	10.1' touch screen, Win10 in Chinese and English, monitor all the processes of pipetting and dispensing
Power Supply	A.C. 100~240 V, 50/60 Hz, 300 VA
Dimensions (L*W*H)	540*740*670 mm
Weight	80 Kg

## Ordering Information

Cat. #	Description	Qty.
NAES-DC48	DC48 Automated Sample Preparation System	1 Set/Carton

## BCM2500 Multifunctional Vortex Mixer

### Features

- **Multimode:** optional intermittent pulse blending mode
- **Convenience:** adapt special tube holders for easy observation
- **Compatibility:** suitable for various specifications of centrifuge tubes, 96 and 384 well plates

### Parameters

Model	BCM2500
Speed Range	500~2500 rpm
Speed Accuracy	±1 rpm
Orbit	3.6 mm
Timing Range	0 s~99 h 59 min
Interval Range	1~99 s
Interval Operation Timing Range	1~999 s
Maximum Load	4.5 Kg
Power Supply	A.C 100~230 V, 50/60 Hz
Power	75 W
Dimensions (L*W*H)	426*246*474 mm

### Ordering Information

Cat. #	Description	Qty.
BCM2500-E	Multifunctional Vortex Mixer	1 Set/Carton
BCM-2500-PM15	Foam tube holder 15 mL	1 Pc/Box
BCM-2500-PM50	Foam tube holder 50 mL	1 Pc/Box
BCM-2500-SD/XD	Top and bottom foam tray (standard accessory)	1 Pc/Box



Foam Tube Holder 50 mL



Foam Tube Holder 15 mL

## Solid Phase Extraction Vacuum Manifolds

The SPE Vacuum Manifolds realize activating, loading, rinsing, eluting and other processes in SPE sample pretreatment by controlling the pressure.

### Features

- **Accuracy:** individual valves control the flow rate independently
- **Compatibility:** the height of the test tube rack is adjustable

### Parameters

Model	SPEMF12G	SPEMF24G-S
Ports	12	24
Lid	Polyoxymethylene	Polyoxymethylene
Glass Vacuum Chamber	Quartz	Quartz
Pressure Resistance	-80 Kpa	-80 Kpa
Stable Pressure	0~80 Kpa	0~80 Kpa
Test Tubes	≤ 105 mm, Φ10/Φ13/Φ15	≤ 105 mm, Φ10/Φ13/Φ15

### Ordering Information

Cat. #	Description	Qty.
SPEMF12G-E	12-Port SPE Vacuum Manifold, square shape, individual flow valve, transparent glass	1 Set/Carton
SPEMF24G-S-E	24-Port SPE Vacuum Manifold, square shape, individual flow valve, transparent glass	1 Set/Carton

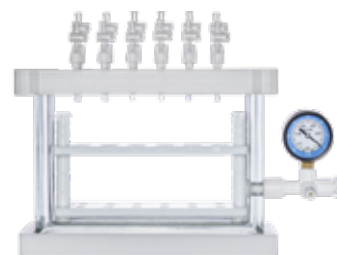

12-Port SPE Vacuum Manifold

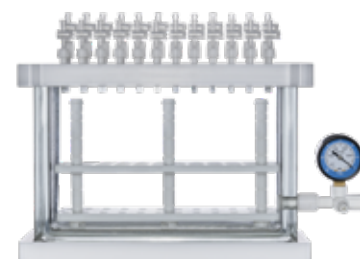

24-Port SPE Vacuum Manifold



## Vacuum Manifolds

The manifolds are adapted to 48/96/384 well plates and Luer-inlet columns to eliminate repetition of pipetting and centrifugation in traditional nucleic acid extraction methods.

### Features

- **Reliability:** made of anti-corrosion and durable material
- **Uniformity:** the compact design ensures uniform flow rate during extraction at negative pressure
- **Convenience:** eliminate repeated operations of centrifugation and pipetting in traditional methods to improve efficiency

### Applications

Universal Vacuum Manifolds	Nucleic acid extraction, solid phase extraction, protein precipitation, QuEChERS, phospholipids removal, Oligo synthesis of deprotection, ammonolysis and other processes etc.
Double-Layer Vacuum Manifolds	Enable filtration and extraction at same time for nucleic acid extraction, solid phase extraction, protein precipitation, phospholipids removal, etc.
Micro-Filter Plate Vacuum Manifolds	Protein kinase and phosphatase assays, protein purification, receptor interaction assays, protein binding assays, ELISPOT assays, mass spectrometry, fluorescent dye removal

### Ordering Information

Cat. #	Description	Qty.
009803-R-E	Universal Vacuum Manifolds (rose red)	1 Set/Carton
009803-B-E	Universal Vacuum Manifolds (sapphire blue)	1 Set/Carton
009804-R-E	Double-Layer Vacuum Manifolds (rose red)	1 Set/Carton
009804-B-E	Double-Layer Vacuum Manifolds (sapphire blue)	1 Set/Carton
009807-R-E	Micro-Filter Plate Vacuum Manifolds (rose red)	1 Set/Carton
009807-B-E	Micro-Filter Plate Vacuum Manifolds (sapphire blue)	1 Set/Carton

### Vacuum Pump

biocomma® Vacuum Pumps are designed to work with vacuum manifolds. Utilizing diaphragm vacuum technology without oil to eliminate contamination of media that occurs in rotary vane pumps.

### Parameters

Oil-Free Vacuum Pump	Portable	Adjustable
Model	SPEMFP01-E	SPEMFP02-E
Ultimate Pressure	0.08 MPa	0.02~0.08
Max. Flow	10 L/min	5~30 L/min
Power	55 W	90 W
Power Supply	A.C. 220 V, 50/60 Hz	A.C. 220 V, 50/60 Hz
Weight	3 Kg	3.8 Kg

### Ordering Information

Cat. #	Description	Qty.
SPEMFP01-E	Portable Oil-Free Vacuum Pump, ultimate pressure 0.08 MPa	1 Set/Carton
SPEMFP02-E	Adjustable Oil-Free Vacuum Pump, adjustable pressure: 0.02~0.08, waste collection bottle included	1 Set/Carton



## 96-Well Plate Nitrogen Evaporator

The nitrogen concentration device combines microcomputer processing and PID control. The working principle is to blow nitrogen rapidly, continuously and uniformly to the surface of sample.

According to the evaporation speed and boiling point of the solvent, the heating temperature is set to complete rapid anaerobic concentration of large samples, which improves the recovery and reproducibility of the target analyte.

Sample preparation in clinical research and testing, drug screening, hormone analysis, liquid phase and mass spectrometry.



### Features

- **Anti-pollution:** independent gas needles avoid cross contamination.
- **Adjustable:** standard gas needle is 80 mm and the height of needles holder is adjustable.
- **Accuracy:** temperature controlling is accurate, extensive, and convenient for calibration.
- **Safety:** protective lifting system is secure to use.
- **Scale:** lifting system with scale is positioned accurately.
- **Uniformity:** excellent and uniform heat transfer.



### Parameters

Model	BCN9602	BCN9603
Temperature Range	RT + 5~150 °C	RT ~ 80 °C
Timing Range	1 min ~ 99 h 59 min	1 min ~ 99 min
Max. Movement	275 mm	35 mm
Max. Gas Pressure	0.1 Mpa	0.6 Mpa
Max. Gas Flow	10 L/min	25 L/min
Air Inlet Outer Diameter	Φ7 mm	Φ8 mm
Needle Length	80 mm (suitable tube diameter <Φ10 mm)	80 mm (suitable tube diameter <Φ10 mm)
Power	400 W	600 W
Power Supply	A.C. 110/220 V, 50/60 Hz	A.C. 220 V, 50/60 Hz
Weight	5.5 Kg	6.5 Kg
Dimensions (L*W*H)	220*260*445 mm	259*310*365 mm

### Ordering Information

Cat. #	Description	Qty.
BCN9602-E	96-Well Plate Nitrogen Evaporator (110 V)	1 Set/Carton
BCN9602-E1	96-Well Plate Nitrogen Evaporator (220 V)	1 Set/Carton
BCN02	Gas Control Valve	1 Pc/Box
BCN9603-E	96-Well Plate Intelligent Nitrogen Evaporator (110V)	1 Set/Carton
BCN9603-E1	96-Well Plate Intelligent Nitrogen Evaporator (220V)	1 Set/Carton

## BCY96 Positive Pressure 96 Processor

BCY96 Positive Pressure 96 Processor uses a continuous positive pressure gas source to drive variable viscosity liquids through each well of 96-well plate. Applying parallel gas pressure from top of the device ensures highly uniform flow rate across 96 wells.

### Features

- **Stability:** flow rates are highly uniform between wells. Pressure is constant in each well
- **Efficiency:** provide excellent flow rate for viscous samples. Universal design fits all SPE 96 well plates
- **Reproducibility:** improve the reproducibility of solid-phase supported liquid-liquid extraction (SLE), solid-phase extraction (SPE) and protein precipitation filtration (PPT)
- **Easy to Use:** adjustable gas pressure is up to 100psi



BCY9602-E



BCY9601-E

### Parameters

Model	BCY9601	BCY9602
Throughput	1~96	1~96
96-Well Output Working Pressure	Low pressure area: 0~15 psi High pressure area: 0~95 psi	Low pressure area: 0~15 psi High pressure area: 0~100 psi
External Working Air Pressure	0.35~0.7 Mpa	0.35~0.7 Mpa
Flatness of Movable Platen	Height error $\leq \pm 0.1$ mm	Height error $\leq \pm 0.1$ mm
96-Well Gas Pressure Uniformity	$\leq \pm 10\%$	$\leq \pm 10\%$
Operating Humidity	10~90%	10~90%
Operating Temperature	10~40 °C	10~40 °C
Applicable Consumables	96-well extraction plate, 2 ml collection plate	96-well extraction plate, 1 ml collection plate, 2 ml collection plate
Operation Method	Switch knob control	Switch knob control
Power Mode	Pneumatic control, no external power supply required	Pneumatic control, no external power supply required
Dimensions (L*W*H)	260*300*360 mm	260*300*330 mm
Weight	8 Kg	8 Kg

### Ordering Information

Cat. #	Description	Qty.
BCY9601-E	Positive Pressure 96 Processor	1 Set/Carton
BCY9602-E	Positive Pressure 96 Processor (includes adapters to fit more plates)	1 Set/Carton

## BCS901 Heat Sealer

Rapid ceramics platen heating technology reaches 170 °C in 300 s avoiding adhesion. The screen is real-time display. Compatible easily pierced foils are suitable for PE, PP, and PS microplates plates.

### Parameter

Model	BCS9601
Sealing Temperature	80 ~ 200 °C (Minimum adjustable unit 1.0 °C)
Temperature Accuracy	±1 °C
Temperature Uniformity	±1 °C
Sealing Time	0.5 ~ 10 s (Minimum adjustable unit of 0.1s)
Compatible Plate Material	PP (polypropylene) / PS (polystyrene) / PE (polyethylene)
Compatible Plate Types	Various standard multi-well plates: PCR plates (full skirt, half skirt, and no skirt), deep well plates, Elisa plates, etc
Compatible Film Material	Foil-polypropylene, transparent polyester fiber-polypropylene, transparent polymer, transparent thin polymer, foil
Sealing Pressure Range	Level 1-5
Compatible Plate Height	9~48 mm, no adjustment needed
Front Panel Material	Fireproof ABS
Heat Sealing Platform Material	Ceramics
Power Supply	A.C. 220 V / 110 V, 50/60 Hz
Maximum Input Power	300 W
Dimension (L*W*H)	180*360*380 mm
Weight	12 Kg

### Ordering Information

Cat. #	Description	Qty.
BCS9601-E	Heat Sealer	1 Set/Carton
RFM02	Heat Sealing Foils, easy pierce	100 Sheets/Box



## UGF Noiseless Ultrasonic Cleaner

The multiple sound reduction design meets the general laboratory requirements of cleaning, extraction, emulsification, mixing, dispersion, etc. The transmission power of highly efficient ultrasonic transducer is 50/60 W to the conversion .

### Parameters

Specification	UC-10-E
Capacity	10 L
Ultrasound Input Power	300 W
Ultrasound Frequency	40 Hz
Heating Power	300 W
Temperature Range	RT~80 °C
Time Setting Range	1~999 min / Normally open
Inner Sink Dimensions (L*W*H)	300*240*150 mm
Dimensions (L*W*H)	328*266*292 mm
Power Supply	A.C. 110V

### Ordering Information

Cat. #	Description	Qty.
UC-06-E	Noiseless Ultrasonic Cleaner, 6 L, power 150 W	1 Set/Carton
UC-10-E	Noiseless Ultrasonic Cleaner, 10 L, power 300 W	1 Set/Carton
UC-15-E	Noiseless Ultrasonic Cleaner, 15 L, power 400 W	1 Set/Carton



LED Screen



Smart Chip



Laser Cutting



Exquisite Details

Distributed by:  
**CliniSciences Group**

## Manual Pipettes

### Features

- Wide measuring range from 0.1  $\mu$ L to 10 mL
- EN/IOS 08655 standard calibration, and online calibration are available
- The lower half can be sterilized at high temperature and pressure

### Ordering Information

Cat. #	Channels	Range	Qty.
DL-2.5	1	0.1~2.5 $\mu$ L	1 Pc/Box
DL-10	1	0.5~10 $\mu$ L	1 Pc/Box
DL-20	1	2~20 $\mu$ L	1 Pc/Box
DL-50	1	5~50 $\mu$ L	1 Pc/Box
DL-100	1	10~100 $\mu$ L	1 Pc/Box
DL-200	1	20~200 $\mu$ L	1 Pc/Box
DL-1001	1	100~1000 $\mu$ L	1 Pc/Box
DL-1002	1	200~1000 $\mu$ L	1 Pc/Box
DL-5000	1	1000~5000 $\mu$ L	1 Pc/Box
DL-10000	1	2~10 mL	1 Pc/Box
DL-10-8	8	0.5~10 $\mu$ L	1 Pc/Box
DL-50-8	8	5~50 $\mu$ L	1 Pc/Box
DL-50-12	12	5~50 $\mu$ L	1 Pc/Box
DL-300-8	8	50~300 $\mu$ L	1 Pc/Box
DL-300-12	12	50~300 $\mu$ L	1 Pc/Box



## Bottletop Dispensers

### Features

- Wide capacity range of 0.5-100 mL
- Chemical resistance
- Various accessories are available
- Partial or whole sterilization at high temperature is available
- Pro series designed with backflow valve

### Ordering Information

Cat. #	Range	Qty.
DLP-5	0.5~5 mL	1 Pc/Box
DLP-5-Pro	0.5~5 mL	1 Pc/Box
DLP-10	1~10 mL	1 Pc/Box
DLP-10-Pro	1~10 mL	1 Pc/Box
DLP-25	2.5~25 mL	1 Pc/Box
DLP-25-Pro	2.5~25 mL	1 Pc/Box
DLP-50	5~50 mL	1 Pc/Box
DLP-50-Pro	5~50 mL	1 Pc/Box
DLP-100-Pro	10~100 mL	1 Pc/Box





# Empower Your Brand with Our Manufacturing

Localized production to enhance customer satisfaction  
and strengthen competitiveness

Biocomma has a specialized factory in Shenzhen and a comprehensive industrial park in Huizhou, with an industrial area covering 60,000 m<sup>2</sup>. We are certified with ISO 9001:2015 and ISO 13485:2016 quality management systems.

In collaboration with the Shanghai Institute of Organic Chemistry of the Chinese Academy of Sciences and the College of Materials Science and Engineering at Shenzhen University, Biocomma has established an integrated research and development base, showcasing advanced capabilities in cross-disciplinary production of life science tools, including reagents and consumables. We offer customized services for the following products.



Bottled Buffers



Dry Blend Buffered Packs



Nucleic Acid Purification Columns



Solid Phase Extraction (SPE) Cartridges



QuEChERS Solutions



Filter & Frits



Erlenmeyer Flasks & Transfer Caps



Square Media Bottles



Dehydrated Culture Media

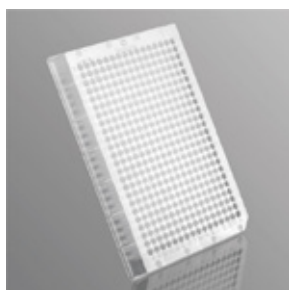

High Throughput Consumables



OEM & ODM



## Filters & Frits

Biocomma offers custom service for lab frits/filters, microfluidic filters, medical suction liner filters, medical self sealing little filters, air filtration filters, water purifier filters, etc.



## Precision Injection

Biocomma opens molds for plastic column tubes and multi-well plates, such as solid phase extraction (SPE) cartridges, peptide synthesis columns, FPLC columns, other protein purification columns, and 96-well or 384-well plates for high-throughput applications. At the same time, based on our porous plastic technology platform, we provide customized frits to meet your flexible customization needs.



## Biological Buffers

Biocomma has specially launched the bottled and powder biological buffers customization service including medical grade buffers, cell culture buffers, sample storage buffers, washing buffers, electrophoresis buffers, antigen retrieval buffers according to the scope of application Liquid and other basic buffers. All products are manufactured in the GMP workshop and can be customized according to your flexible and diverse experimental needs.



## Logo Printing

Biocomma provides a custom logo printing service for our products. Our skilled design team is here to assist in creating or enhancing logos to make your products distinct and memorable. Elevate your branding with our personalized logo printing service.



## ODM

Biocomma extends ODM service for various products, such as spin columns, fix rings, and silica membranes. We welcome clients to provide their raw materials, for example, silica membrane, and we'll take care of the production process of spin columns, ensuring top-quality results. Our ODM solution provides a tailored approach to meet your specific needs.

# CliniSciences Group

## Austria

Company: CliniSciences GmbH  
Address: Sternwartestrasse 76, A-1180  
Wien - Austria  
Telephone: +43 720 115 580  
Fax: +43 720 115 577  
Email: [oesterreich@clinisciences.com](mailto:oesterreich@clinisciences.com)  
Web: <https://www.clinisciences.com>



## Belgium

Company: CliniSciences S.R.L  
Address: Avenue Stalingrad 52, 1000  
Brussels - Belgium  
Telephone: +32 2 31 50 800  
Fax: +32 2 31 50 801  
Email: [belgium@clinisciences.com](mailto:belgium@clinisciences.com)  
Web: <https://www.clinisciences.com>



## Denmark

Company: CliniSciences ApS  
Address: Oesterbrogade 226, st. 1,  
Copenhagen, 2100 - Denmark  
Telephone: +45 89 888 349  
Fax: +45 89 884 064  
Email: [danmark@clinisciences.com](mailto:danmark@clinisciences.com)  
Web: <https://www.clinisciences.com>



## Finland

Company: CliniSciences ApS  
Address: Oesterbrogade 226, st. 1,  
Copenhagen, 2100 - Denmark  
Telephone: +45 89 888 349  
Fax: +45 89 884 064  
Email: [suomi@clinisciences.com](mailto:suomi@clinisciences.com)  
Web: <https://www.clinisciences.com>



## France

Company: CliniSciences S.A.S  
Address: 74 Rue des Suisses, 92000  
Nanterre- France  
Telephone: +33 9 77 40 09 09  
Fax: +33 9 77 40 10 11  
Email: [info@clinisciences.com](mailto:info@clinisciences.com)  
Web: <https://www.clinisciences.com>



## Germany

Company: Biotrend Chemikalien GmbH  
Address: Wilhelm-Mauser-Str. 41-43,  
50827 Köln - Germany  
Telephone: +49 221 9498 320  
Fax: +49 221 9498 325  
Email: [info@biotrend.com](mailto:info@biotrend.com)  
Web: <https://www.biotrend.com>



## Iceland

Company: CliniSciences ApS  
Address: Oesterbrogade 226, st. 1,  
Copenhagen, 2100 - Denmark  
Telephone: +45 89 888 349  
Fax: +45 89 884 064  
Email: [island@clinisciences.com](mailto:island@clinisciences.com)  
Web: <https://www.clinisciences.com>



## Ireland

Company: CliniSciences Limited  
Address: Ground Floor, 71 lower Baggot street  
Dublin D02 P593 - Ireland  
Telephone: +353 1 6971 146  
Fax: +353 1 6971 147  
Email: [ireland@clinisciences.com](mailto:ireland@clinisciences.com)  
Web: <https://www.clinisciences.com>



## Italy

Company: CliniSciences S.r.l  
Address: Via Maremmana inferiore 378  
Roma 00012 Guidonia Montecelio - Italy  
Telephone: +39 06 94 80 56 71  
Fax: +39 06 94 80 00 21  
Email: [italia@clinisciences.com](mailto:italia@clinisciences.com)  
Web: <https://www.clinisciences.com>



## Netherlands

Company: CliniSciences B.V.  
Address: Kraaijenhoffstraat 137A,  
1018RG Amsterdam, Netherlands  
Telephone: +31 85 2082 351  
Fax: +31 85 2082 353  
Email: [nederland@clinisciences.com](mailto:nederland@clinisciences.com)  
Web: <https://www.clinisciences.com>



## Norway

Company: CliniSciences ApS  
Address: Oesterbrogade 226, st. 1,  
Copenhagen, 2100 - Denmark  
Telephone: +45 89 888 349  
Fax: +45 89 884 064  
Email: [norge@clinisciences.com](mailto:norge@clinisciences.com)  
Web: <https://www.clinisciences.com>



## Poland

Company: CliniSciences sp.Z.o.o.  
Address: ul. Rotmistrza Witolda Pileckiego 67  
lok. 200 - 02-781 Warszawa -Poland  
Telephone: +48 22 307 0535  
Fax: +48 22 307 0532  
Email: [polska@clinisciences.com](mailto:polska@clinisciences.com)  
Web: <https://www.clinisciences.com>



## Portugal

Company: Quimigen Unipessoal LDA  
Address: Rua Almada Negreiros, Lote 5, Loja 14,  
2615-275 Alverca Do Ribatejo - Portugal  
Telephone: +351 30 8808 050  
Fax: +351 30 8808 052  
Email: [info@quimigen.com](mailto:info@quimigen.com)  
Web: <https://www.quimigen.pt>



## Spain

Company: CliniSciences Lab Solutions  
Address: C/ Hermanos del Moral 13  
(Bajo E), 28019, Madrid - Spain  
Telephone: +34 91 269 40 65  
Fax: +34 91 269 40 74  
Email: [espana@clinisciences.com](mailto:espana@clinisciences.com)  
Web: <https://www.clinisciences.com>



## Sweden

Company: CliniSciences ApS  
Address: Oesterbrogade 226, st. 1,  
Copenhagen, 2100 - Denmark  
Telephone: +45 89 888 349  
Fax: +45 89 884 064  
Email: [sverige@clinisciences.com](mailto:sverige@clinisciences.com)  
Web: <https://www.clinisciences.com>



## Switzerland

Company: CliniSciences Limited  
Address: Marktgasse 18 8302 Kloten -  
Switzerland  
Telephone: +41 (044) 805 76 81  
Fax: +41 (044) 805 76 75  
Email: [switzerland@clinisciences.com](mailto:switzerland@clinisciences.com)  
Web: <https://www.clinisciences.com>



## UK

Company: CliniSciences Limited  
Address: 11 Progress Business center, Whittle  
Parkway, SL1 6DQ Slough- United Kingdom  
Telephone: +44 (0)1753 866 511  
or +44 (0) 330 684 0982  
Fax: +44 (0)1753 208 899  
Email: [uk@clinisciences.com](mailto:uk@clinisciences.com)  
Web: <https://www.clinisciences.com>



## USA

Company: Biotrend Chemicals LLC  
Address: c/o Carr Riggs Ingram,  
500 Grand Boulevard, Suite 210 Miramar  
Beach, FL 32550- USA  
Telephone: +1 850 650 7790  
Fax: +1 850 650 4383  
Email: [info@biotrend-usa.com](mailto:info@biotrend-usa.com)  
Web: <https://www.biotrend-usa.com>

